



Load Shedding and Reactive Power Compensation of Distribution System Using TLPO Algorithm under Different Load Models

Oday Hameed Abdel Mohsen^{1,2} Mohammed Kdair Abd^{1*}

¹*Department of Electrical Engineering, University of Technology- Iraq, Iraq*

²*Ministry of Water Resources, Iraq*

* Corresponding author's Email: mohammed.k.abd@uotechnology.edu.iq

Abstract: The most critical strategy to keep the electrical grid from collapsing is load shedding. However, by itself, this approach is unable to achieve system stabilization, as well as frequency and voltage have an impact on the network's stability as well. Traditional load-shedding designs do not take into account the various load models and the declining economic cost associated with load disconnecting. When calculating load flow, multiple load models like constant power (C.P), constant current (C.I), constant impedance (C.Z), and combined load (ZIP) may be involved, but all loads are typically described as constant electrical power (C.P). In this article, the idea of a dual approach to load shedding and capacitor placement is adopted to maximize the amount of power loss reduction in the distribution network, taking into account different load models and determining the best one that leads to the least losses, the best voltage profile, and the lowest cost. To minimize load shedding for the network and choose the optimal capacitor size and location, the Teaching Learning Based Optimization (TLBO) algorithm. The outcomes showed that using the ZIP scenario is the superior model for all scenarios in terms of reducing active power losses by about 66.018% and lowering the percentage of load shedding to 19.5195%.

Keywords: Load Shedding, TLPO, Load Models, OCP.

1. Introduction

Currently, electric power grids operate in close proximity to the stability threshold, making voltage stability a critical factor that requires significant attention during both the management and planning of these grids. Evidence has shown that the instability of the voltage could contribute to substantial system failures caused by the inequity between the production of power and the load required within the power system. Therefore, load-shedding strategies are employed as a final resort to prevent the power grid from collapsing under major failures [1].

The Under-Voltage-Load-Shedding (UVLS) process might be considered a feasible resolution in cases where voltage instability is anticipated. The traditional UVLS design is activated when the voltage stability criteria are violated, and the scheme of a UVLS is employed when the voltage level drops below a pre-established threshold [2]. Voltage

stability takes great significance in studies of electrical power grids to reach a more reliable and stable system. Because these systems are characterized by slow dynamics, static methods are used when analysing voltage stability. Also, the (V-Q) curve method is considered the most common in evaluating voltage stability and identifying stressed buses [3]. Minimum load shedding can be attained utilizing linear programming methodology as an optimization technique because of its strength and speed so that optimum load flow is obtained. This technique is capable of restoring voltages to acceptable values as well as reducing the rate of load shedding [4]. Intelligent algorithms such as particle swarm optimization (PSO), evolutionary particle swarm optimization (EPSO), ant-lion optimization (ALO), and others are considered effective mathematical methods that can be relied upon to solve complex non-linear problems with high efficiency. Therefore, they are used to find the

optimal approach to load shedding in low-voltage situations [5].

When a power system is exposed to overload conditions, this results in increased power loss and decreased voltage levels, which threatens the stability of the system. The voltage stability index identifies the critical buses for load shedding while ALO calculates the amount of load that is shedding. The optimal load shedding optimizes the network by reducing losses and improving the voltage profile [6].

Restoring the system to a healthy state and protecting it from collapse requires optimal load shedding. Initially exhausted buses are identified utilizing the fast voltage stability index. The outcomes indicate an enhanced voltage profile with decreased load shedding and convergence time. Particle swarm optimization (PSO) and genetic algorithms (GA) have been used for this purpose as a hybrid approach in smart networks [7].

Systems of distribution mostly utilize capacitors for reactive power correction. Furthermore, capacitors are employed to reduce active loss and improve voltage profiles. Depending on how and where the capacitors are placed in the network will determine the benefits of this type of compensation, and for this purpose, the improved binary particle swarm optimization (IBPSO) algorithm was used [8]. Some researchers have suggested adding capacitors at an optimal place with an optimal value through various methods of optimization, for example, dice game optimization (DGO) [9] and the harmonic search (HS) algorithm [10]. These measures aim to reduce the risk of voltage breakdown occurring and improve the stability and voltage profile. However, these shunt capacitors have some operational issues including resonance [11], and are unable to continuously supply a varied reactive power.

Optimal Capacitor Placement (OCP) is the most feasible and cost-effective method when saving costs go above the overall cost of investment. In reference [12], it was proposed to reduce the function of cost by selecting OCP to improve the voltage profile of the system with lower losses of the active power and a higher power factor. Utilizing genetic algorithms, the ideal capacitor placement and problem-sizing solution are implemented. The network is evaluated and resolved using the Electrical Transient Analyzer Program (ETAP), and GA is used to minimize the objective function.

Previous works have several drawbacks, including their tendency to prioritize power quality or reliability enhancement separately, also without considering other related concerns. As in [13] when using flower pollination algorithm (FPA), a function was proposed for the sole purpose of minimizing

losses in a radial distribution system (RDS), without considering improving the voltage profile or reliability of the system, as a result of which the voltage limitations of the network buses were broken. The reliability and power quality of the distribution network were also taken into account together when implementing the binary salt swarm algorithm (BSSA) as an optimization process, which resulted in an improved voltage profile, while the improvement in active power loss reduction reached 48.43% [14]. Distributed generation techniques are also among the techniques used to address distribution system problems that require high purchase and installation costs, so they are used in specific cases [15]. The absence of load modelling in the power system calculations has a significant effect on the accuracy of the results, and when load models are used and collected into a single computational model the voltage profile improves and losses are reduced [16]. Moreover, a few papers in the literature [17] employed the dual approach for a sizable standard system.

Based on the TLPO algorithm for its superior performance, simplicity of concept, and ability to handle multi-objective functions, a dual optimization technique combining load shedding and capacitor placement is used to reduce the amount of load shedding and choose the optimal size and location of capacitors to optimize the distribution network. The proposed algorithm maximizes the amount of energy loss reduction in the distribution network, taking into account different load models and identifying the best one that leads to the least losses, the best voltage profile, and the lowest cost. In the proposed technique, the objective function (*obj.fun.f*) is created by combining three individual objective functions: actual power loss minimization (*obj.fun.1*), voltage profile adjustments (*obj.fun.2*), and growth of the annual cost of savings (*obj.fun.3*) as described in Section 6. This allowed the proposed algorithm to handle the voltage profile and active power loss and save the cost together. The TLBO algorithm is employed with the Newton-Raphson load flow method for the RDS with multi-objective functions. Various representations of load were evaluated, and the ZIP form indicated the most effective model, with simultaneous load shedding and capacitor placement producing the best outcomes in terms of boosting yearly financial savings, minimizing losses of power, and improving voltage profiles. Each keeps in mind the RDS constraints.

The structure of this paper is as follows: In Sections 2 and 3, the optimal load shedding and OCP in a distribution system are presented, respectively. Exponential and polynomial load models are the

subject of Section 4, while Section 5 provides an explanation of the TLBO. The objective function, general constraints, and the concept of voltage recovery are discussed in Section 6, Section 7 contains the outcomes and assessment. Section 8 contains the final comments.

2. Optimal Load Shedding (OLS)

The UVLS is a safety mechanism designed to avert a collapse of voltage in the occurrence of a significant deficiency of reactive power supplies in certain local or system-wide regions. It has become the preferred approach for power utilities due to its cost-effectiveness in addressing voltage stability concerns. However, before implementing UVLS, certain factors must be considered, such as determining where load shedding should occur, how much should be shed at each location, and when it should take place [18]. By implementing suitable load-shedding techniques, it is possible to minimize investment losses and enhance the voltage profile for financial purposes.

An OLS approach can effectively mitigate the consequences of instability in the voltage and failures of the system. The use of a convenient optimization algorithm can provide several benefits, including precise calculation of the required load-shedding amount, dependable performance, and compatibility with modern and intricate systems [19]. Additionally, identifying critical power system lines can be achieved by analysing the optimal load-shedding amount.

In this article, load shedding and capacitor placement are used as a dual approach to optimize the distribution network.

3. Optimal Capacitor Placement (OCP)

The capacitors compensate for the loss of reactive power caused by voltage drops and excessive power losses. As a result, the best capacitor sets are combined into the distribution network to boost power factor, enhance the profile of the voltage, and reduce losses. To overcome this problem, four types of optimization approaches are used: analytical, computational programming, heuristic, and artificial intelligence methods [20].

The optimal capacitor placement aims to balance capacitor cost and system benefits, considering purchase, installation, and operating costs. Since the arrangement of capacitors is in separate size sets with equal pricing for non-linear set sizes of capacitors, the cost is identified using a (step-like) function [21].

4. Load modeling in a load flow study

Many power system analyses are based on load flow, such as distribution network design and development studies, optimization problems, etc. Since it is common in load flow to use the constant power model as a load model, this may not be appropriate and accurate because loads vary in the distribution network based on power, current, impedance, or a combination of these factors. Therefore, it may lead to inaccurate results and prove ineffective.

The findings from power flow and stability investigations are crucial in determining the necessary improvements for system performance. So, it is essential to integrate all component models into a single model to accurately characterize the entire system. The modeling of load has a significant influence on findings, including benefits such as loss reduction, improved voltage profiles, voltage regulation within set bounds, and accurate computation of both reactive and active power requirements at every node in the network.

The simplest basic model used to solve power flow problems is the static load model, which has two variations: the polynomial load model and the exponential load model [22].

4.1 Model for exponential load

This model can be used to calculate both the reactive and active power of the bus bar, which depends on the voltage and frequency. Presented as an exponential function of the voltage, the static load design as a formula:

$$P_d = P_o \left(\frac{V}{V_o} \right)^{p_e} \quad (1)$$

$$Q_d = Q_o \left(\frac{V}{V_o} \right)^{q_e} \quad (2)$$

Where:

P_d, Q_d : the load's required active and reactive power, P_o, Q_o : the consuming power for (P and Q), p_e, q_e : (P and Q) exponents, V : voltage source, V_o : voltage of the rated.

The usual values for p_e and q_e were determined from measurements utilizing the parameter estimate process [23].

4.2 Polynomial load model

Electrical power systems have various types of loads, and the percentage of these loads at each node fluctuates over time. The most widely used model is

called the ZIP model, which combines the P, I, and Z models [24]. It appears as:

$$P = \alpha P_o V^2 + \beta Q_o V + \gamma P_o \quad (3)$$

$$Q = \alpha Q_o V^2 + \beta Q_o V + \gamma Q_o Q_d = Q_o \left(V/V_o \right)^{q_e} \quad (4)$$

$$\alpha + \beta + \gamma = 1 \quad (5)$$

At any given system node, the proportional contribution of constants (Z), (I), and (P) is represented by α , β , and γ . The examination of real active and reactive powers is solely based on voltage variations, while the difference in power due to frequency variations is not explored. This study selects values for these parameters as $\alpha=0.6$, $\beta=0.2$, and $\gamma=0.2$, which yield optimal results for reducing losses and improving voltage profiles.

5. Teaching learning-based optimization (TLBO)

The TLBO algorithm, which mimics the teaching-learning process in a classroom, is a population-based heuristic stochastic swarm intelligent algorithm. Instead of having students go through evolutionary processes like selection, crossover, and mutation, TLBO looks for optimal learning by having each learner seek to match the teacher's expertise, who is regarded as the most knowledgeable person in society. Due to its straightforward idea and excellent efficiency, TLBO has been effectively applied to numerous real-world challenges. A regular distribution between the lower and upper bounds of the resolve variables is used to generate the premier population, which has the population size and the number of design variables [25]. It has gained popularity among researchers due to its simple concept, lack of algorithm-specific parameters, fast convergence, easy implementation, and effectiveness.

The TLBO algorithm consists of two phases: the teacher's phase and the learners phase. During the teacher phase, the best-performing learner in the population is chosen to be the teacher, whose task is to train other learners and enhance their overall performance. In contrast, in the learners phase, each student chooses another learner at random to engage with, with the objective of enhancing their class's mean grade [26].

5.1 Teacher phase

The teaching phase pertains to the teacher facilitating the learning process for students. The

teacher, being the most knowledgeable and experienced in a particular subject among the population, is considered the superior learner. It is possible to determine the difference between the teacher's performance and the average performance of students in each topic through calculation [27].

Assuming there are m design variables, n learners (with $K = 1, 2, \dots, n$), and $(M_{j,i})$ represents the mean result of learners for the subject j (where $j=1, 2, \dots, m$), any iteration can be evaluated. The overall best results $X_{total-kbest,i}$ achieved by the entire population of learners across all subjects can be determined by identifying the performance of the top learner ($kbest$). It is also possible to determine the discrepancy between the current average result for every subject and the result each subject's teacher achieved as flow:

$$Differene_Mean_{j,k,i} = r_i (X_{j,kbest,i} - T_F M_{j,i}) \quad (6)$$

The result of the top-performing student in subject j is denoted as $X_{j,kbest,i}$. The teaching factor, T_F determines the adjusted mean value. A random number, r_i is generated within the range of 0 to 1. The value of T_F can be either 1 or 2 and is randomly determined with equal probability using a formula such as Eq. (7):

$$T_F = \text{round}[1 + \text{rand}(0,1)\{2 - 1\}] \quad (7)$$

The TLBO algorithm does not consider as T_F a parameter and instead randomly assigns its value using Eq. (7). The algorithm performs more effectively when T_F is set to either 1 or 2. In the teacher phase, the existing answer is revised based on the $Differene_Mean_{j,k,i}$ using Eq. (8):

$$X'_{j,K,i} = X_{j,K,i} + Differene_Mean_{j,K,i} \quad (8)$$

The worth of $X_{j,K,i}$ is updated to $X'_{j,K,i}$ and only accepted if it results in an improved function worth. These passable values are preserved when the teacher's phase is ended and serve as input for the learner phase, which is dependent on the teacher phase.

5.2 Learner phase

In order to enhance their understanding, a learner engages with other learners randomly. Considering the magnitude of the (n) population, the learning process during this phase may be shown below: Randomly choose P and Q as your two students so that:

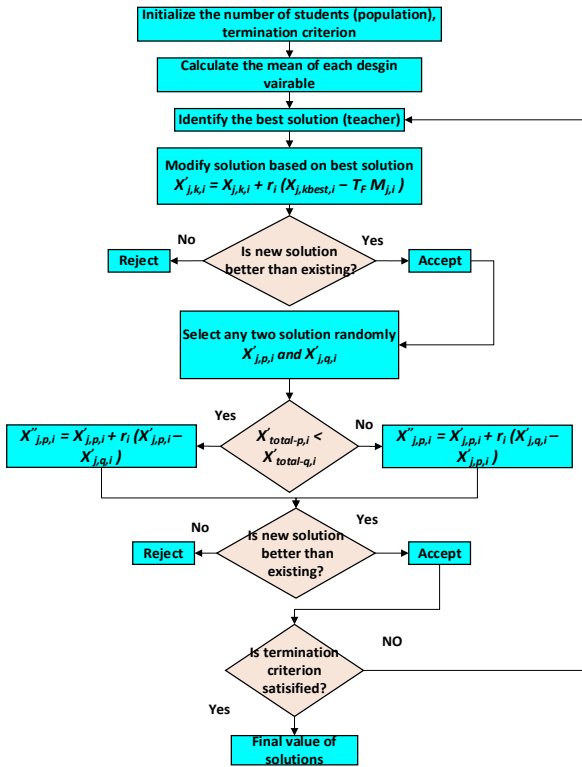

Figure. 1 The flow chart of TLBO

Table 1. TLBO algorithm parameters

Parameter	Worth
Population	10
Maximum loop=number of Iteration	50

$$X'_{total-p,i} \neq X'_{total-q,i} \tag{9}$$

At the conclusion of the teacher stage, $X'_{total-p,i}$ represents the latest value of $X_{total-p,i}$ and $X'_{total-q,i}$ represents the latest value of $X_{total-q,i}$.

$$X''_{j,p,i} = X'_{j,p,i} + r_i (X'_{j,p,i} - X'_{j,q,i}), \text{ if } X'_{total-p,i} < X'_{total-q,i} \tag{10}$$

$$X''_{j,p,i} = X'_{j,p,i} + r_i (X'_{j,q,i} - X'_{j,p,i}), \text{ if } X'_{total-q,i} < X'_{total-p,i} \tag{11}$$

If it leads to a greater function value, then consent to $X''_{j,p,i}$. Table 1 displays the most efficient TLBO parameters. Fig. 1 shows the flowchart that illustrates the TLBO method.

6. Objective functions and general constraints

Three combined individual objective functions and several constraints are used in this proposed method, as described below.

6.1 Objective functions

The multi-objective functions can be advantageous and used to enhance the voltage values of the buses and reduce the loss of power through techniques of optimization. The subsequent are instances of these functions (*obj. fun.*):

6.1.1. (P_{loss}) reduction (*obj.fun.1*)

Actual power loss reduction (*obj.fun.1*).

$$(obj. fun. 1) = P_{loss} \tag{12}$$

$$P_{loss} = \sum_{l=1}^{N_{bra}} P_{lossl} \text{ KW} \tag{13}$$

$$P_{lossl} = I_l^2 * R_l \text{ KW} \tag{14}$$

Where:

P_{loss} , denote the overall magnitude of losses, N_{bra} , denote the total number of network branches, R_l , denote the branch's resistance i , I_l , denote the current of branch i .

6.1.2. (Voltage profile modifications (*obj.fun.2*))

The voltages on buses need to remain within specific limits.

$$obj. fun. 2 = V_c * Re_v + C_c * Re_i \tag{15}$$

Where:

V_c , are restrictions on bus voltages, C_c , are the current restrictions on branches, Re_v , is the bus penalty parameter is equal to zero if the bus voltage falls to an acceptable value, Re_i , is the penalty parameter for branch currents is assigned a value of zero when the current does not exceed the thermal limit. Additionally, bus voltages are required to fall within a specific range.

6.1.3. Growth in the yearly cost of savings (*obj.fun.3*)

Reactive compensation aims to increase yearly savings on costs from the loss of active power and capacitor installation expenses, including purchase, installation, and operational costs. The savings are calculated by comparing base-scenario costs with suggested solutions [28].

$$obj. fun. 3 = \max(C_{sav}) = C_{AB} - C_{AA} \tag{16}$$

Where:

C_{AB} , Before using any approach, the annual loss cost is expressed in (\$), C_{AA} , is the price of yearly

losses after employing the methods in (\$), C_{sav} . Display the annual cost of saving in (\$).

The values and prices of the capacitors are detailed in [29], and [30] provides a description of the cost characteristics of the capacitors that were utilized in the cost computations.

The constructed objective function ($obj. fun. f$) is created by combining the three individual objective functions ($obj. fun. 1$), ($obj. fun. 2$), and ($obj. fun. 3$) as follows:

$$obj. fun. f = obj. fun. 1 + obj. fun. 2 + obj. fun. 3 \quad (17)$$

6.2 General limitations

The primary objective of these power system restrictions is to prevent violations of quality standards related to safety, reliability, and economic factors.

6.2.1. Technical restrictions

These types of technical restrictions are known as technical limits, and they are classified into three groups:

a. Bus voltage constraints

To keep energy flowing, the amount of voltage on each system bus needs to be within the allowed range.

$$|V_j^{min.}| \leq |V_j| \leq |V_j^{max.}| \quad j \in N_{bus}. \quad (18)$$

Where

N_{bus} :The number of network buses. The allowed range is $(0.95 p. u - 1.05 p. u)$.

b. The limits of current for network branches

The branch's current must maintain load power transfer while not exceeding its maximum value for safety reasons.

$$|I_l| \leq |I_{lm}|, l \in N_{bra}. \quad (19)$$

The highest current worth of every branch is listed in [31].

c. Limitations on the total size of capacitors

The RDS requires that the total size of the capacitors (Q_{CT}) not exceed the entire reactive power of the load (Q_{load}) [32].

$$Q_{CT} \leq Q_{load} \quad (20)$$

6.2.2. Operating limitations

Two categories of limits, known as equality limitations, exist:

The system's radial configuration is validated by obtaining the outcome of a matrix [A], which, as seen in [16], indicates the quantity of buses as columns and the quantity of branches as rows.

b. Limitation of actual power balancing:

$$P_{sup} = P_{dem} + P_{loss} \quad (21)$$

Where: P_{sup} is the power of a substation, P_{dem} is the overall demand power.

The suggested approach aims to decrease the occurrence of load shedding for the network and choose the optimal capacitor value and location. Fig.2 shows the flowchart that illustrates this algorithm.

6.3 Concept of voltage recovery

The voltage enhancement may have happened in some buses but not others, or it may have worsened in some buses. It is challenging to deal with a large number of voltages in buses to determine the presence of an improved voltage level in the whole

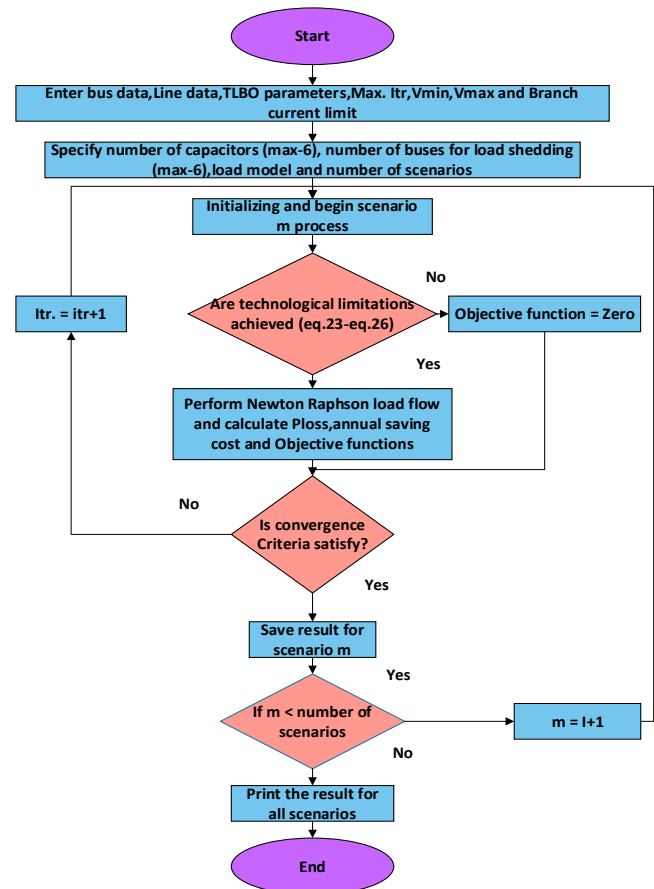

Figure. 2 Flowchart of the proposed algorithm

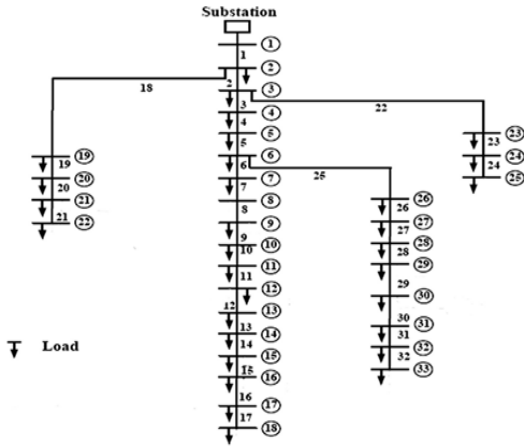

Figure. 3 IEEE 33-bus RDS single-line

system. The recovery index of voltage (V_{rec}) utilized for controlling all voltages of buses is as follows [1]:

$$V_{rec. \%} = \frac{(V_{av})_{AS} - (V_{av})_{BS}}{(V_{av})_{BS}} \times 100\% \quad (22)$$

$$V_{av} = \frac{\sum_{i=1}^{N_{bus}} V_i}{N_{bus}} \quad (23)$$

Where:

$(V_{av})_{AS}$ is the average voltage after scenario execution, $(V_{av})_{BS}$ is the average voltage before scenario execution, V_{av} is the average voltage, (V_i) is the voltage of bus i .

7. Results of the simulation and analysis

The TLBO approach is utilized to limit the area of search in order to improve the application of load-shedding situations and capacitor instillation strategies. The IEEE RDS (33-buses) is used, and it is displayed in Fig. 3.

The system is comprised of one main feeder and three lateral feeders, 33-buses, and 37 branches. The loads on the system are rated at 3715 (kW) and 2300 (kVAr), with a 12.66 (kV) system voltage rating and 100 (MVA). The reference [33] contains the test system data.

The network is tested using different load models, which include five scenarios as follows:

1. Solely load-shedding, 2. Solely capacitor placement, 3. Load-shedding followed by capacitor placement, 4. Capacitor placement followed by load-shedding, and 5. Load-shedding and capacitor placement are carried out simultaneously.

7.1 Comparing the scenarios with the load model

Table 2 presents the findings from contrasting all scenarios with the normal load model, (C.P) model. Based on the TLBO algorithm's optimal position, all

scenarios use the locations of the three capacitor buses and the four shedding buses. The results in the Table 2 show that the fifth scenario (simultaneous load-shedding and capacitor placement), which reduced active losses, improved voltage profiles, and increased annual cost savings, produced the greatest outcomes. Lowering active losses and reducing the shedding percentage of the load are enhanced in Table 3 when using (C.I) model (constant current model) and their continued to improve in Table 4 with (C.Z) constant impedance model and Table 5 with ZIP model respectively. With the ZIP model (fifth scenario), Active loss was reduced to 66.018% compared to the normal case, and load shedding was reduced to 19.5195%.

The results of the tables also demonstrate that the ZIP, when compared to the other models, is the best model for all scenarios in lowering active power losses and reducing load shedding percentage. The voltage profiles are shown in Fig. 4 to 7, and Fig. 8 to 11 demonstrate the power losses of branches for all scenarios in every model. Those indicate that the simultaneous load shedding and capacitor placement scenario is superior to the other.

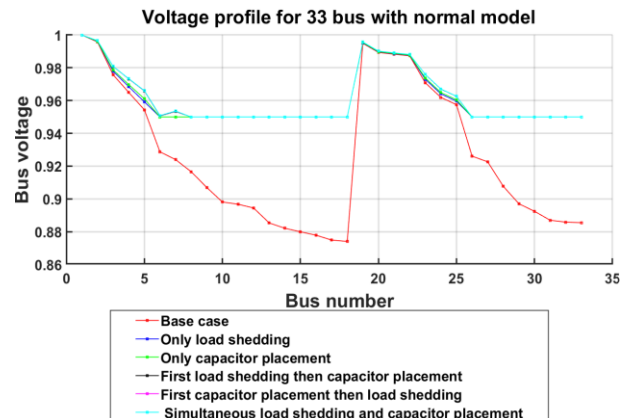

Figure. 4 Voltage profile readings for 33-bus networks using the normal model

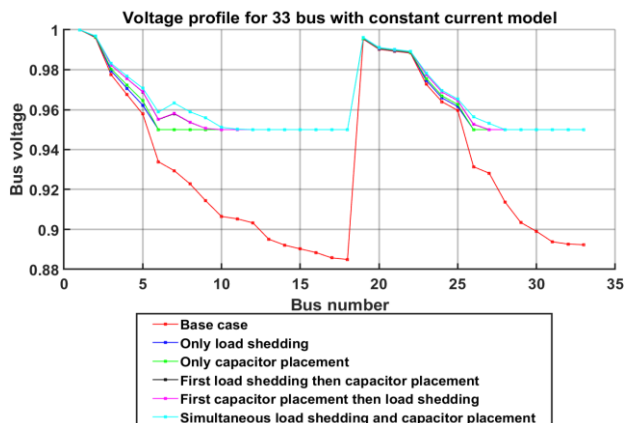

Figure. 5 Voltage profile readings for 33-bus networks using the (C.I) model

Table 2. Results of 33-bus network with normal (C.P) model for all cases

PARAMETERS	BASE CASE	DLS	OCP	DLS-OCP	OCP-DLS	SIMULTANEOUS DLS-OCP
ACTIVE POWER LOSS	152.9419	77.3292	72.7121	68.6091	64.5143	60.4224
REACTIVE POWER LOSS	102.3895	45.1509	74.3128	69.9877	65.892	61.7999
SHEDDING BUS LOCATION	NIL	NIL	NIL	7 13 9 10	7 13 9 10	7 13 9 10
CAPACITOR BUS LOCATION	NIL	NIL	7 13 9	7 13 9	7 13 9	7 13 9
CAPACITOR SIZE	NIL	NIL	600 300 300	600 300 300	600 300 300	600 300 300
TOTAL CAPACITOR COST	NIL	NIL	342	342	342	342
REDUCING COSTS	NIL	49.43%	45.067%	47.624%	49.698%	52.977%
MINIMUM VOLTAGE	0.87403	0.95	0.95	0.95	0.95	0.95
MAXIMUM VOLTAGE	1	1	1	1	1	1
EXECUTION TIME	0.24196	31.0892	33.0146	30.2074	30.9637	69.8602
LOAD SHEDDING PERCENTAGE	NIL	21.2702	NIL	NIL	22.588	21.7199

Table 3. Results of 33-bus network with (C.I) model for all cases

PARAMETERS	BASE CASE	DLS	OCP	DLS-OCP	OCP-DLS	SIMULTANEOUS DLS-OCP
ACTIVE POWER LOSS	131.8522	70.4295	66.3628	62.7481	59.1393	55.4687
REACTIVE POWER LOSS	88.1045	41.7337	67.7322	63.9911	60.3821	56.6652
SHEDDING BUS LOCATION	NIL	NIL	NIL	7 13 9 10	7 13 9 10	7 13 9 10
CAPACITOR BUS LOCATION	NIL	NIL	7 13 9	7 13 9	7 13 9	7 13 9
CAPACITOR SIZE	NIL	NIL	600 300 300	600 300 300	600 300 300	900 300 300
TOTAL CAPACITOR COST	NIL	NIL	342	342	342	374.7
REDUCING COSTS		46.585%	40.950%	43.691%	46.429	49.166%
MINIMUM VOLTAGE	0.88494	0.95	0.95	0.95	0.95	0.95
MAXIMUM VOLTAGE	1	1	1	1	1	1
EXECUTION TIME	0.22264	32.5896	32.1556	31.2666	32.0363	73.019
LOAD SHEDDING PERCENTAGE	NIL	21.6608	NIL	NIL	22.8699	20.6655

Table 4. Results of 33-bus network with (C.Z) model for all cases

PARAMETERS	BASE CASE	DLS	OCP	DLS-OCP	OCP-DLS	SIMULTANEOUS DLS-OCP
ACTIVE POWER LOSS	121.4679	67.84	63.6586	60.3327	57.0176	53.6465
REACTIVE POWER LOSS	81.0873	40.4649	64.9169	61.4757	58.1574	54.7325
SHEDDING BUS LOCATION	NIL	NIL	NIL	7 13 9 10	7 13 9 10	7 13 9 10
CAPACITOR BUS LOCATION	NIL	NIL	7 13 9	7 13 9	7 13 9	7 13 9
CAPACITOR SIZE	NIL	NIL	600 300 300	600 300 300	600 300 300	900 300 600
TOTAL CAPACITOR COST	NIL	NIL	342	342	342	374.7
REDUCING COSTS		44.150%	38.128%	40.867%	43.596%	46.320%
MINIMUM VOLTAGE	0.89081	0.95	0.95	0.95	0.95	0.95
MAXIMUM VOLTAGE	1	1	1	1	1	1
EXECUTION TIME	0.21528	30.6455	33.7885	31.1081	32.2962	74.4221
LOAD SHEDDING PERCENTAGE	NIL	21.3715	NIL	NIL	22.92	21.9777

Table 5. Results of 33-bus network with ZIP model for all cases

PARAMETERS	BASE CASE	DLS	OCP	DLS-OCP	OCP-DLS	SIMULTANEOUS DLS-OCP
ACTIVE POWER LOSS	117.2247	66.395	62.6941	59.4904	56.2958	51.9724
REACTIVE POWER LOSS	78.2236	40.0507	63.9281	60.591	57.3936	53.1353
SHEDDING BUS LOCATION	NIL	NIL	NIL	7 13 9 10	7 13 9 10	7 13 9 10
CAPACITOR BUS LOCATION	NIL	NIL	7 13 9	7 13 9	7 13 9	7 13 9
CAPACITOR SIZE	NIL	NIL	600 300 300	600 300 300	600 300 300	900 900 300
TOTAL CAPACITOR COST	NIL	NIL	342	342	342	434.4
REDUCING COSTS		43.361%	36.712%	39.445%	42.170%	45.708%
MINIMUM VOLTAGE	0.89333	0.95	0.95	0.95	0.95	0.95
MAXIMUM VOLTAGE	1	1	1	1	1	1
EXECUTION TIME	0.22307	32.4801	31.0862	30.2584	32.3484	72.0394
LOAD SHEDDING PERCENTAGE	NIL	21.4015	NIL	NIL	23.1434	19.5195

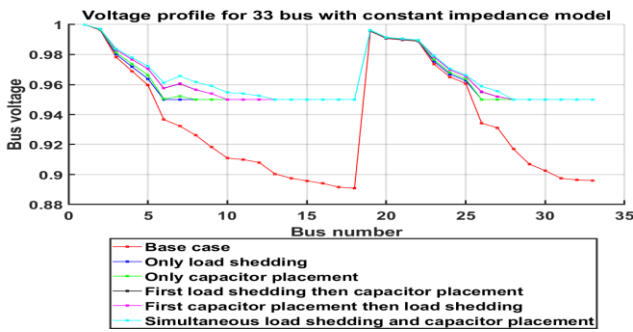

Figure. 6 Voltage profile readings for 33-bus networks using the (C.Z) model.

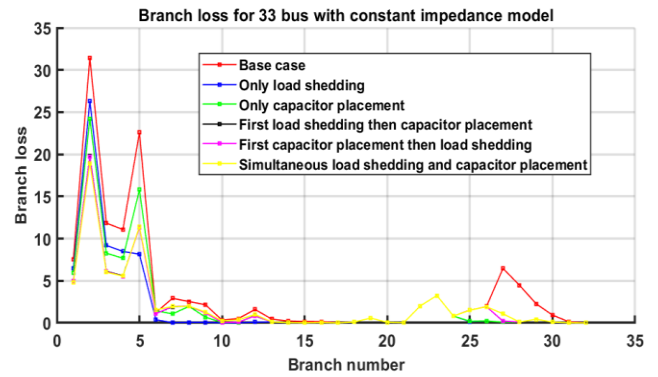

Figure. 10 Branch loss for 33-bus with constant impedance model

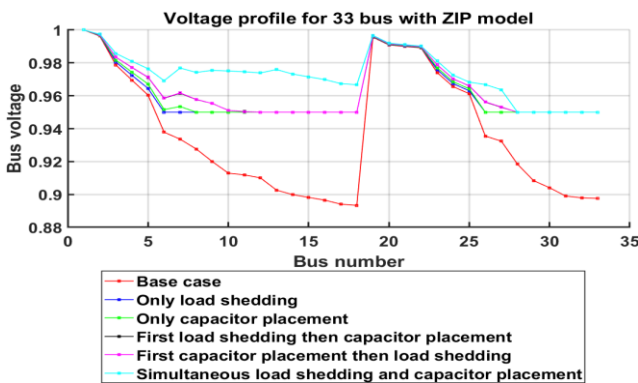

Figure. 7 Voltage profile readings for 33-bus networks using the ZIP model

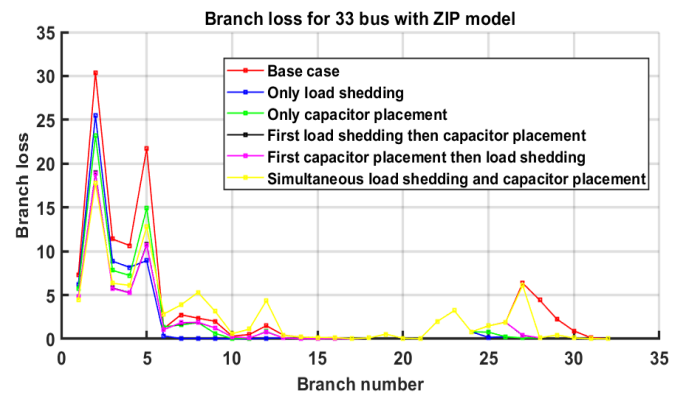

Figure. 11 Branch loss for 33-bus with ZIP model

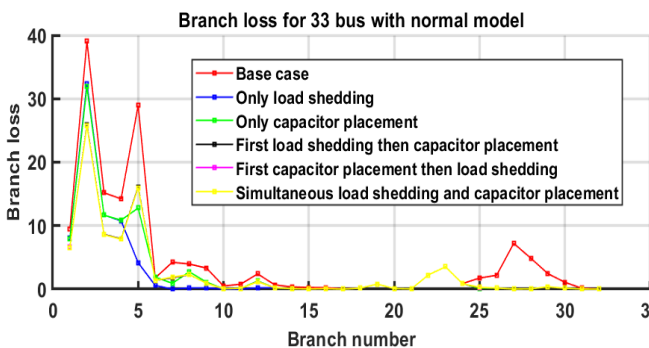

Figure. 8 Branch loss for 33-bus with normal model

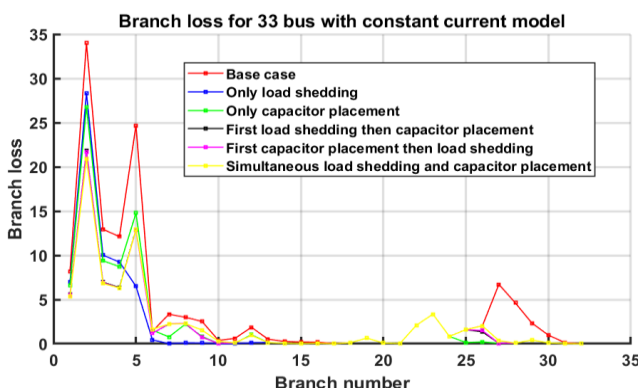

Figure. 9 Branch loss for 33-bus with constant current model

The proportion of voltage recovery in the network was calculated using Eq. (22) and Eq. (23) and is 3.9%. The network's voltage recovery results from the suggested approach are compared to those from other approaches to ensure its dependability. It has been shown that the outcomes of the suggested solution are superior to or similar to it to some extent, as shown in Table 6.

7.2 Comparison with other algorithms

The comparison of different algorithms for simultaneous load shedding and capacitor placement using the ZIP model in the 33-Bus is shown in Table 7. This technique is also proven to be the best when assessed with other approaches to improving the profile of voltage, lowering significant losses, and saving cost.

Table 6. Comparison of the voltage recovery index

The approach	Voltage recovery %
TLBO (ZIP Model)	3.9 %
FPA [13]	2.7 %
BSSA [14]	3.8 %

Table 7. Comparison of different algorithms for (simultaneous DLS-OCP)

Parameters	FPA [13]	BSSA [14]	IBPSO [8]	TLBO (ZIP Model)
Power losses (kw)	139.075	104.512	93.061	51.9724
Minimum voltage (p.u)	0.9327	0.957	0.9587	0.95
Loss Reduction (%)	30.26	48.434	54.08	66.018
Location of buses	30,13,24	19,30,33	7,12,25,30,33	7,13,9
Capacitor sizes (KVAR)	900,450,450	600,600,600	600,300,300,600,300	900,900,300

It is clear from the results of the tables that the range of voltage limits for the system buses falls within the permissible range ($0.95 p.u - 1.05 p.u$), where the minimum voltage was $0.95 p.u$ and the maximum voltage was $1 p.u$, and the total size of the capacitors (Q_{CT}) did not exceed the full reactive power of the load (Q_{load}), which means that the limitations on the voltages of the system buses and the total size of the capacitors are not broken when using this proposed technique, unlike what happens in some OCP methods.

We can also see in Table 7 that the minimum voltage value in [13] broke the voltage constraint ($0.95 p.u - 1.05 p.u$). The minimum voltage value in [14] is higher than that of this proposed technique, but when calculating the voltage improvement level

of the whole system using the recovery index of voltage (V_{rec}), the proposed technique is better as shown in Table 6.

8. Conclusion

The TLPO algorithm is used in this research to evaluate load shedding and efficient reactive power adjustment for distribution systems. The TLBO optimization approach is used to find the optimal capacitor value and location, although it reduces the load that will be shed. The results demonstrate that the suggested approaches are effective in attaining optimal capacitor placement and the minimal amount of load shedding in RDS while considering different load models as well as handling multi-objective problems.

The fifth scenario (simultaneous load-shedding and capacitor placement) gave the best results, lowering active losses, optimizing voltage profiles, and increasing yearly cost savings. The ZIP model is found to be superior for positioning shaded buses and sizing capacitors for all scenarios compared to other models. With the ZIP model (fifth scenario), Active loss was reduced to 66.018% compared to the normal case, and load shedding was reduced to 19.5195%. This approach is also shown to be the best when compared with different algorithms in Table 7. The proposed approach's voltage recovery results were compared to other methods, revealing that the proposed solution's results are superior compared to those of other methods.

In future work, the following subjects could be added to this article:

- 1- Study the network in the disturbance condition following removing one line and reattaching the network by another tie-line.
- 2- Use this technique for a sizable standard system.

Notation list

Symbol	Parameters	Symbol	Parameters
P_d, Q_d	The load's required active and reactive power	V_c	Restrictions on bus voltages
p_e, q_e	(P and Q) exponents	C_c	The current restrictions on branches
V	Voltage source	Re_v	The penalty parameter of bus voltage
V_r	Voltage of the rated	Re_i	The penalty parameter for branch currents
$\alpha, \beta, \text{ and } \gamma$	The proportional contribution of constants (Z), (I), and (P)	C_{AB}	The annual loss cost before using any approach
$M_{j,i}$	The mean result of learners for the subject j	C_{AA}	The annual loss cost after using any approach
$X_{j,kbest,i}$	The result of the top-performing student in subject j	C_{sav}	The annual cost of saving

$Differene_Mean_{j,K,i}$	The discrepancy between the current average result for every subject and the result each subject's teacher achieved	$V_j^{min.}$	Minimum voltage of bus j
T_F	The teaching factor	$V_j^{max.}$	Maximum voltage of bus j
r_i	Random number	V_j	The voltage of bus j
$X_{total-kbest,i}$	The overall best results	N_{bus}	The number of network buses
$X_{j,K,i}$	The result of the student k in subject j	I_l	The branch's current
$X'_{j,K,i}$	Updated value for $X_{j,K,i}$	I_{lm}	Maximum branch's current
P, Q	Two students during Learner phase	$N_{bra.}$	The number of network branches
$X_{total-P,i}$	The overall result of the teacher stage to student P	Q_{CT}	The total size of the capacitors
$X_{total-Q,i}$	The overall result of the teacher stage to student Q	Q_{load}	The entire reactive power of the load
$X'_{total-P,i}$	The latest value of $X_{total-P,i}$	P_{dem}	The overall demand power
$X'_{total-Q,i}$	The latest value of $X_{total-Q,i}$	P_{sup}	The power of a substation
$X''_{j,p,i}$	Greater function value	$V_{rec.}$	The recovery index of voltage
P_{loss}	The overall magnitude of losses	$(V_{av})_{AS}$	The average voltage after scenario execution
N_{bra}	The total number of network branches	$(V_{av})_{BS}$	The average voltage before scenario execution
R_l	The branch's resistance i	V_{av}	The average voltage
I_l	The current of branch i	V_i	The voltage of bus i

Conflicts of Interest

The authors declare no conflict of interest.

Author Contributions

Conceptualization, M. K. Abd; methodology, M. K. Abd and O. H. Abdel Mohsen; software, O. H. Abdel Mohsen; validation, M. K. Abd; formal analysis, M. K. Abd and O. H. Abdel Mohsen; investigation, O. H. Abdel Mohsen; resources, O. H. Abdel Mohsen; data curation, O. H. Abdel Mohsen; writing—original draft preparation, O. H. Abdel Mohsen; writing—review and editing, M. K. Abd; visualization, O. H. Abdel Mohsen; supervision, M. K. Abd; project administration, M. K. Abd.

References

- [1] R. H. DeemedAl-Rubayi and M. K. Abd, "Emergency load shedding for voltage stability enhancement: With particular reference to the iraqi national power grid", *Int. J. Intell. Eng. Syst.*, Vol. 13, No. 2, pp. 52-62, 2020, doi: 10.22266/ijies2020.0430.06.
- [2] Y. Lee and H. Song, "Decentralized load shedding method based on voltage stability margin index using synchrophasor measurement technology", *Electron.*, Vol. 7, No. 11, 2018, doi: 10.3390/electronics7110277.
- [3] M. Chakravorty and S. Patra, "Voltage stability analysis using conventional methods", *Int. Conf. Signal Process. Commun. Power Embed. Syst. SCOPES 2016 - Proc.*, pp. 496–501, 2017, doi: 10.1109/SCOPES.2016.7955879.
- [4] L. Hakim, A. Z. Nafisah, H. Gusmedi, and K. Khairudin, "Voltage Profile Improvement through Load Shedding Action Using Linear Programming-based Optimal Power Flow", *Insist*, Vol. 3, No. 1, p. 115, 2018, doi: 10.23960/ins.v3i1.115.
- [5] M. Usman, A. Amin, M. M. Azam, and H. Mokhlis, "Optimal under voltage load shedding scheme for a distribution network using EPSO algorithm", In: *Proc. of 2018, IEEE 1st Int. Conf. Power, Energy Smart Grid, ICPEGS 2018*, pp. 1-6, 2018, doi: 10.1109/ICPEGS.2018.8384 525.
- [6] Z. M. Yasin, I. N. Sam'On, N. A. Salim, H. Mohamad, and N. A. Wahab, "Optimal undervoltage load shedding using ant lion optimizer", *Int. J. Simul. Syst. Sci. Technol.*, Vol. 17, No. 41, pp. 47.1-47.6, 2017, doi: 10.5013/IJSSST.a.17.41.47.
- [7] R. M. Larik, M. W. Mustafa, M. N. Aman, T. A. Jumani, S. Sajid, and M. K. Panjwani, "An improved algorithm for optimal load shedding in power systems", *Energies*, Vol. 11, No. 7, pp. 1-16, 2018, doi: 10.3390/en11071808.
- [8] M. Sedighzadeh, M. Dakhem, M. Sarvi, and H. H. Kordkheili, "Optimal reconfiguration and capacitor placement for power loss reduction of distribution system using improved binary particle swarm optimization", *Int. J. Energy Environ. Eng.*, Vol. 5, No. 1, pp. 1-11, 2014, doi: 10.22266/ijies2024.0430.53

- 10.1007/s40095-014-0073-9.
- [9] M. Dehghani, Z. Montazeri, O. P. Malik, K. Al-Haddad, J. M. Guerrero, and G. Dhiman, "a New Methodology Called Dice Game Optimizer for Capacitor Placement in Distribution Systems", *Electr. Eng. Electromechanics*, Vol. 0, No. 1, pp. 61–64, 2020, doi: 10.20998/2074-272x.2020.1.10.
- [10] M. Suneetha, R. Srinivasa Rao, and B. Subramanyam, "Implement the harmonic search algorithm with optimum location of capacitors sizing and dispatchable dgs to control the reactive power on inter connected bus system", *J. Adv. Res. Dyn. Control Syst.*, Vol. 11, No. 1 Special Issue, pp. 880–889, 2019, doi: 10.11591/ijra.v7i3.pp149-158.
- [11] T. Yuvaraj and K. Ravi, "Multi-objective simultaneous DG and DSTATCOM allocation in radial distribution networks using cuckoo searching algorithm", *Alexandria Eng. J.*, Vol. 57, No. 4, pp. 2729–2742, 2018, doi: 10.1016/j.aej.2018.01.001.
- [12] M. J. Tahir, B. A. Bakar, M. M. Alam, and M. S. U. Mazlihum, "Optimal capacitor placement in a distribution system using ETAP software", *Indones. J. Electr. Eng. Comput. Sci.*, Vol. 15, No. 2, pp. 650-660, 2019, doi: 10.11591/ijeecs.v15.i2.pp650-660.
- [13] V. Tamilselvan, T. Jayabarathi, T. Raghunathan, and X. S. Yang, "Optimal capacitor placement in radial distribution systems using flower pollination algorithm", *Alexandria Eng. J.*, Vol. 57, No. 4, pp. 2775-2786, 2018, doi: 10.1016/j.aej.2018.01.004.
- [14] A. Nasser Hussain, W. Rafa Abed, and M. Muneer Yaqoob, "Dual Strategy of Reconfiguration with Capacitor Placement for Improvement Reliability and Power Quality in Distribution System", *J. Eng. (United Kingdom)*, Vol. 2023, 2023, doi: 10.1155/2023/1943535.
- [15] N. A. Yusof, H. Mokhlis, M. Karimi, J. A. Laghari, H. A. Illias, and N. M. Sapari, "Under-voltage load shedding scheme based on voltage stability index for distribution network", In: *Proc. of 3rd IET International Conference on Clean Energy and Technology (CEAT) 2014*, Kuching, pp. 1-5, 2014, doi: 10.1049/cp.2014.1470.
- [16] W. K. S. Al-Jubori and A. N. Hussain, "Optimum reactive power compensation for distribution system using dolphin algorithm considering different load models", *Int. J. Electr. Comput. Eng.*, Vol. 10, No. 5, pp. 5032-5047, 2020, doi: 10.11591/IJECE.V10I5. PP5032-5047.
- [17] H. F. Kadom, A. N. Hussain, and W. K. S. Al-Jubori, "Dual technique of reconfiguration and capacitor placement for distribution system", *Int. J. Electr. Comput. Eng.*, Vol. 10, No. 1, pp. 80-90, 2020, doi: 10.11591/ijece.v10i1.pp80-90.
- [18] R. Verayah, A. Mohamed, H. Shareef, and I. Zainal Abidin, "Metody UVLS w zastosowaniu do monitorowania stabilności systemu energetycznego i zapobiegania jego zapaściom", *Prz. Elektrotechniczny*, Vol. 90, No. 7, pp. 99-103, 2014, doi: 10.12915/pe.2014.07.19.
- [19] N. M. Sapari, H. Mokhlis, J. A. Laghari, A. H. A. Bakar, and M. R. M. Dahalan, "Application of load shedding schemes for distribution network connected with distributed generation: A review", *Renew. Sustain. Energy Rev.*, Vol. 82, No. 2016, pp. 858-867, 2018, doi: 10.1016/j.rser.2017.09.090.
- [20] A. Askarzadeh, "Capacitor placement in distribution systems for power loss reduction and voltage improvement: A new methodology", *IET Gener. Transm. Distrib.*, Vol. 10, No. 14, pp. 3631–3638, 2016, doi: 10.1049/iet-gtd.2016.0419.
- [21] H. Zayandehroodi, M. Amirinejad, H. Afzalynia, and A. Noori, "Particle Swarm Optimization Algorithm for Optimal Capacitor Placement on Electric Power Distribution Networks", 2014, Available online at <https://api.semanticscholar.org/CorpusID:212590408>.
- [22] N. Rostami and M. O. Sadegh, "The Effect of Load Modeling on Load Flow Results in Distribution Systems", *American Journal of Electrical and Electronic Engineering*, Vol. 6, No. 1, pp. 16-27, 2018, doi: 10.12691/ajeec-6-1-3.
- [23] U. Eminoglu and M. H. Hocaoglu, "A new power flow method for radial distribution systems including voltage dependent load models", *Electr. Power Syst. Res.*, Vol. 76, No. 1-3, pp. 106-114, 2005, doi: 10.1016/j.eprsr.2005.05.008.
- [24] S. Mok, S. Elangovan, C. Longjian, M. M. A. Salama, and L. Cao, "A new approach for power flow analysis of balanced radial distribution systems", *Electr. Power Components Syst.*, Vol. 28, No. 4, pp. 325-340, 2000.
- [25] A. Tiwary, "Reliability enhancement of distribution system using Teaching Learning based optimization considering customer and energy based indices", *Int. J. Futur. Revolut. Comput. Sci. Commun. Eng.*, Vol. 3, No. 10, pp. 58-62, 2017.
- [26] Y. K. Chen, S. X. Weng, and T. P. Liu,

- “Teaching-learning based optimization (TLBO) with variable neighborhood search to retail shelf-space allocation”, *Mathematics*, Vol. 8, No. 8, 2020, doi: 10.3390/MATH8081296.
- [27] P. J. Pawar and R. V. Rao, “Parameter optimization of machining processes using teaching-learning-based optimization algorithm”, *Int. J. Adv. Manuf. Technol.*, Vol. 67, No. 5-8, pp. 995–1006, 2013, doi: 10.1007/s00170-012-4524-2.
- [28] D. Das, “Optimal placement of capacitors in radial distribution system using a Fuzzy-GA method”, *Int. J. Electr. Power Energy Syst.*, Vol. 30, No. 6-7, pp. 361–367, 2008, doi: 10.1016/j.ijepes.2007.08.004.
- [29] A. Elsheikh, Y. Helmy, Y. Abouelseoud, and A. Elsherif, “Optimal capacitor placement and sizing in radial electric power systems”, *Alexandria Eng. J.*, Vol. 53, No. 4, pp. 809-816, 2014, doi: 10.1016/j.aej.2014.09.012.
- [30] A. A. El-Fergany and A. Y. Abdelaziz, “Artificial bee colony algorithm to allocate fixed and switched static shunt capacitors in radial distribution networks”, *Electr. Power Components Syst.*, Vol. 42, No. 5, pp. 427-438, 2014, doi: 10.1080/15325008.2013.856965.
- [31] M. Sedighzadeh, M. Ghalambor, and A. Rezazadeh, “Reconfiguration of Radial Distribution Systems with Fuzzy Multi-Objective Approach Using Modified Big Bang-Big Crunch Algorithm”, *Arab. J. Sci. Eng.*, Vol. 39, No. 8, pp. 6287-6296, 2014, doi: 10.1007/s13369-014-1249-6.
- [32] G. Namachivayam, C. Sankaralingam, S. K. Perumal, and S. T. Devanathan, “Reconfiguration and Capacitor Placement of Radial Distribution Systems by Modified Flower Pollination Algorithm”, *Electr. Power Components Syst.*, Vol. 44, No. 13, pp. 1492-1502, 2016, doi: 10.1080/15325008.2016.1172281.
- [33] Z. Chen, “A Study of Power Distribution System Reconfiguration based on Reliability Indices.”, pp. 40-42, 2016, [Online]. Available: <https://mospace.umsystem.edu/xmlui/bitstream/handle/10355/59899/research.pdf?sequence=2&isAllowed=y>