

EXPERIMENTAL ANALYSIS OF THRESHING MAIZE SEEDS WITH HIGH MOISTURE CONTENT

高含水率玉米籽粒脱粒试验分析

Yujie DENG, Guohai ZHANG*, Aoqi ZHANG, Jitan LIAN, Jia YAO, Xin WANG, Xiaohui YANG¹

School of Agricultural Engineering and Food Science, Shandong University of Technology, Zibo, 255000, China

Tel: +86-15965534882; E-mail: guohaizhang@163.com

DOI: <https://doi.org/10.35633/inmateh-69-12>

Keywords: maize harvesting; maize threshing; orthogonal test

ABSTRACT

To address the problems of high breakage rates, high entrainment losses and many unthreshed kernels when harvesting high moisture content maize seeds, a high moisture content maize seed threshing test was designed based on a multifunctional seed harvester stand designed by this group. In order to determine the optimum operating parameters of the threshing unit, single-factor experiments and orthogonal tests were carried out using the threshing drum speed, concave plate clearance and feed rate as test factors and the crushing rate, un-threshing rate, entrained loss rate and trash content rate as test evaluation indicators. The optimum combination of test factors obtained for the harvesting of maize at 32% to 34% moisture content was a drum speed of 346.55 r/min, a concave plate clearance of 44.39 mm and a feed rate of 9.739 kg/s. After repeated experiments on the bench, the test results with optimum parameters were 6.311% crushing rate, 0.187% un-threshing rate, 0.912% entrained loss rate and 4.251% impurity rate, at which point the crushing rate was the lowest and the other three met national standards.

摘要

针对高含水率玉米籽粒收获时破碎率高、夹带损失大、未脱净籽粒多的问题，基于本课题组设计的多功能籽粒收获机台架设计了高含水率玉米籽粒脱粒试验。为确定脱粒装置的最佳工作参数，以脱粒滚筒转速、凹板间隙和喂入量为试验因素，以破碎率、未脱净率、夹带损失率和含杂率为试验评价指标，进行了单因素实验与正交试验。在进行32%~34%含水率的玉米收获试验时获取的试验因素最优参数组合为滚筒转速为346.55r/min，凹板间隙为44.39mm，喂入量为9.739Kg/s，经过台架的重复实验，最优参数下的试验结果为破碎率为6.311%，未脱净率为0.187%，夹带损失率为0.912%，含杂率为4.251%，此时破碎率最低，其他三项符合国家标准。

INTRODUCTION

In recent years, with the development of China's agricultural mechanization, the level of maize mechanization harvesting has been increasing, and the national average maize harvesting rate reached 80% by 2021, but maize harvesting is mostly based on cob harvesting, and seed harvesting accounts for less than 10%, compared with the United States in the 1980s, which has achieved all maize harvesting for maize seed harvesting (Pan, 2017; Zhang, 2017; Xie, 2021). Maize seed harvesting has the advantages of a short operating process, few intermediate links, low costs and high efficiency compared to cob harvesting, and has become an important means of addressing the high quality development of maize harvesting in China. For the harvesting of maize kernels, the axial threshing device has the advantages of low drum speed, gentle threshing process, long threshing time, thorough threshing, low breakage rate and high removal rate (Zhao et al., 2010). Longitudinal axial flow threshing drums are widely used in medium and large combine harvesters because they offer more advantages in terms of spatial layout of the combine harvester.

To solve the problem of low loss and efficient threshing of high moisture content maize, the process of threshing maize cobs in the threshing system was studied and a maize seed threshing test was designed. A review of data and field research revealed that in field trials of whole maize seed threshing and harvesting machines, maize seed threshing and stripping entered the scavenging system and re-screening device,

¹ Yujie Deng, M.S. Stud. Eng.; Guohai Zhang, As. Ph.D. Eng. Aoqi Zhang M.S. Stud. Eng.; Jitan Lian, M.S. Stud. Eng.; Jia Yao, M.S. Stud. Eng.; Xin Wang, M.S. Stud. Eng.; Xiaohui Yang, M.S. Stud. Eng.

increasing the crushing rate and reducing the un-threshing rate, making it impossible to collect data on the trash content rate. During threshing the maize kernels are not evenly distributed over the entire length of the drum, in a single longitudinal axial flow threshing drum the maize kernels are 90% threshed in the input and threshing section. It is therefore necessary to carry out segmental tests on the threshing process of maize kernels and to analyze the threshing material in segments, to study the rate of contamination, fragmentation, loss and uncleaning of the material, in order to carry out an in-depth study of the threshing mechanism of maize.

Many studies have been carried out by domestic and foreign scholars on maize grain harvesting: Some scholars have developed a mathematical model of material movement in a longitudinal axial flow threshing device, which can be used to guide the design and optimization of the longitudinal axial flow threshing device, and can also analyze the movement of grain in the threshing device (*Miu et al., 2007*). Some scholars concluded that for different varieties of maize cobs, increasing the speed of the threshing drum helps to increase the threshing capacity of the drum (*Tiwari et al., 2010*). Some scholars presented a mathematical model that characterizes the process of threshing and separation from the threshing machine with an axial flow of a thresher, taking into account the following input parameters: material flow, rotor speed, distance between rotor and counter rotor, mean density of processed material, feed speed, length of thresher and separating surface. The mathematical model has been experimentally validated to be a good fit (*Viăduț N.V. et al., 2022*). Some scholars have designed a fuzzy logic controller (FLC) incorporating human expert knowledge to automatically adjustment and control of the harvester to achieve minimal grain losses especially at the position of straw walker and upper sieve (*Omid et al., 2010*). Some scholars have designed a fuzzy control system which combines the knowledge of experienced operators with these data-based models (*Craessaerts et al., 2010*). Some scholars have designed a combine chassis leveling control system. Starting from the identification of a gray box model, a two-layer cascade regulator is designed to control the body roll and pitch angles. In addition, an automatic, data driven tuning protocol that cuts down the time needed for the traditional manual tuning procedure is proposed (*Federico et al., 2023*). Some scholars have recorded the actual field speed of the rice combine used by the operator on a daily basis through field observation measurements. In addition, its impact on grain losses in the rice field was assessed (*Shamilah et al., 2020*). Some scholars have developed mathematical models for the operation of combine harvester cleaning system screens based on the nodal coordinates, velocities and motion acceleration of the combine harvester cleaning system screens (*Ildar et al., 2020*).

A researcher has designed a low-damage combination round-headed spiked tines and segmented circular tube threshing screen plate that can be used for efficient, high-performance maize harvesting (*Qu, 2018*). Some scholars designed a longitudinal axial flow type variable diameter and variable pitch conical threshing drum, which was tested and proven to be suitable for harvesting maize with high moisture content (*Song et al., 2022*). Some scholars have designed an adjustable threshing and separating device. It solves the problem of unstable feeding volume of combine harvesters in the field leading to poor harvesting performance (*Wang et al., 2019*). Some scholars have designed a threshing and separating device for regenerated rice combine harvesters. The device achieves the purpose of making full use of space and improving threshing efficiency (*Li et al., 2022*).

Given the difficulty of collecting experimental data on the threshing and removal of trash residues in maize seed harvesting experiments in the field, this affects the effectiveness of the experiment and increases experimental error. The multifunctional seed harvesting test stand designed by the group is therefore used. The test stand is not equipped with a travelling device and is fed to the cutting table by a conveyor belt. The other working parts are designed and assembled according to the mainstream domestic models. The test stand is powered by 7 motors and the speed of each motor is controlled by a PLC control cabinet. After testing and verification, the stand can simulate the complete threshing process of a combine harvester and meets the requirements of this experiment.

MATERIALS AND METHODS

General design of the multifunctional seed harvesting test stand

The designed test stand consists of a feeding, threshing, scavenging and chopping system. The PLC control cabinet included in it enables the independent speed regulation of each of the seven motors by controlling seven frequency converters. The parameters of each device can be adjusted infinitely. The structure of the test stand is shown in Figure 1.

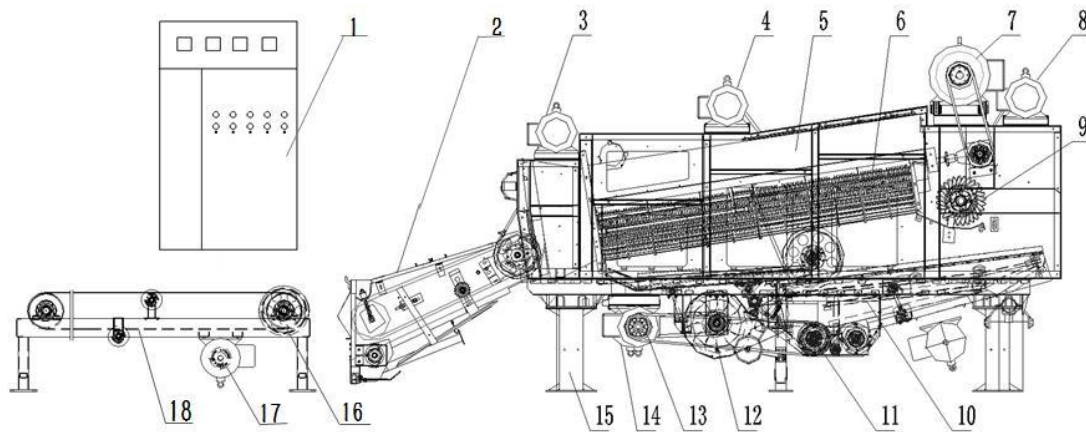

Fig. 1 - Structure of the test bench

1. PLC control cabinet; 2. Over bridge assembly; 3. Over bridge motor; 4. Scavenging motor; 5. Machine wall; 6. Axial flow assembly; 7. Axial flow reluctance motor; 8. Chopper motor; 9. Chopper assembly; 10. Scavenging sieve assembly; 11. Scavenging chamber bottom shell; 12. Scavenging fan; 13. Belt drive; 14. Fan motor; 15. Frame; 16. Conveyor belt drive roller; 17. Conveyor belt motor; 18. Conveyor belt assembly

Operating principle of the multifunctional seed harvesting test stand

When the table is in operation, the crop first enters the spiral conveyor through the conveyor belt and enters the conveyor overpass under the action of the spiral conveyor; the crop enters between the threshing drum and the gap between the concave plates under the action of the rotating screw feed head for threshing and separation; the threshed material enters the sorting system after threshing is completed, and the other miscellaneous residues are conveyed through the drum to the rear shredding system for shredding and discharge (*Shen et al., 2013*). The threshed material entering the sorting system is sorted under the action of the fish scale screen and the fan. The seeds are discharged through the discharge opening by means of a conveyor chum and finally collected by hand, most of the trash is discharged from the tail screen and a part of the mixture of seeds and trash is conveyed by the trash churn to the front of the threshing drum for secondary re-threshing.

EXPERIMENTAL RESEARCH ON MAIZE THRESHING

Test methods

The influence of moisture content on the threshing of maize kernels is mainly generated during the threshing process, so the feeding rate, drum speed and threshing gap, which have a greater influence on the threshing effect, were selected as the test factors, and a single-factor test was conducted at 5 levels within the parameter adjustment range. To study the effect of different levels of each parameter on the threshing effect at different water contents, three excellent levels were selected and then orthogonal tests were carried out to obtain the optimal ratio of threshing parameters at different water contents using response surface analysis.

The test indicators are calculated as follows:

$$Y = \frac{W_3}{W_1} \times 100\% \quad (1)$$

$$S = \frac{W_2}{W_4} \times 100\% \quad (2)$$

$$Z = \frac{W_5}{W_4} \times 100\% \quad (3)$$

$$Q = \frac{W_7}{W_6} \times 100\% \quad (4)$$

where: S is the crushing rate, %;

Y - the impurity rate, %;

Z - the undefined rate, %

Q - the loss rate, %;

W_1 - the total mass of seeds and trash in the material box, kg;

W_2 - is the mass of crushed maize kernels in the material box, kg;

W_3 - is the mass of trash in the material box, kg;

W_4 - is the mass of maize seeds in the material box, kg;

W_5 - is the mass of un-threshing maize seeds in the material box, kg;

W_6 - is the mass of all maize seeds, kg;

W_7 - is the quality of maize seeds on receiving tarp, kg.

Based on the actual operational characteristics of the single longitudinal axial flow maize seed harvester, the adjustment range of the threshing test parameters was determined, as shown in Table 1 below.

Table 1

Adjustment range of bench parameters

Parameters	Adjustment range	Measurement unit
Feeding volume	6~14	kg/s
Roller speed	250~600	r/min
Threshing clearance	25~55	mm
Deflector angle	50~70	°

Test materials

The maize variety tested was Zhengdan 958, taken from a field grown by a local farmer in Zibo, with the parameters shown in Table 2 below. The test material was unthreshed maize cobs taken by hand and harvested in September 2022.

Table 2

Corn size parameters

Parameters	Numerical values
Maize varieties	Zhengdan 958
Maize cob length, mm	175-202
Diameter of the top of the corn, mm	30-36
Maize cob tail diameter, mm	49-51
Maize seed weight per 100 kernels, g	40
Initial moisture content of the seeds, %	32-34

The maize was selected for harvesting from the same lot, with essentially the same growth. At harvesting, the maize was required to be fully mature and free from collapse, and to prevent the loss of moisture from the kernels, a bench test of the highest moisture content was carried out immediately after harvesting, with a theoretical dosage of 2.35 t and an actual estimate of 2.5 t.

Test site: Shandong Yafeng Agricultural Machinery & Equipment Co.

Test apparatus: single longitudinal axial flow maize combine harvesting stand, moisture tester, weighing apparatus.

Test procedure

Before the test starts, carry out the inspection of the threshing and cleaning test bench, check whether the machine chain, pulley, etc. are connected normally; switch on the power, check whether the frequency converter, instrument panel, indicator lights and other parts are displayed normally; press the click start button and check whether there are any strange noises in the motors (Du et al., 2020). After the threshing and cleaning test bench has been inspected, the material boxes are placed on the first cleaning sieve surface to catch and release the maize kernels and debris after threshing. 50 material boxes of 300 mm x 250 mm x 150 mm in length, width and height are densely placed on the sieve surface according to the length and diameter of the threshing drum; the discharge tarp is laid flat at the rear of the test bench to catch and release the maize kernels and debris lost during threshing.

To start the test, first fill a woven bag with maize cobs, 10 kg per bag, and after determining the amount to be fed for this test take a sufficient amount of maize cobs and pour them onto the conveyor belt 1.5 m from the end and lay them backwards for 4 m. Before starting the machine, adjust the threshing gap to meet the test requirements. When starting the machine, start it from the rear of the stand in order to the front, start the stand in the order of the crushing roller, threshing drum and cutting table, and start the conveyor belt when it is running smoothly. After the corn cob has been threshed, the machine is switched off from the front to the rear of the frame, in the order of the conveyor belt, the cutting table, the threshing roller and the crushing roller.

At the end of each trial, the mixture on the discharge tarp was collected, the trash and maize kernels were separated manually and their kernel mass was weighed on an electronic scale to calculate the entrainment loss rate. Samples are removed from the receiver box using the quadratic method, the total mass is weighed using an electronic scale, then the trash, broken kernels and un-threshing kernels are separated manually and the mass of each is weighed using an electronic scale to calculate the percentage of broken, trash and un-threshing kernels. In order to reduce measurement errors, the test data from the three material boxes were combined and the average value was taken as the final maize kernel breakage rate, un-threshing rate and trash content rate.

Single-factor tests

In order to investigate the effect of drum speed, concave plate clearance and cob feed on the rate of broken and unthreshed kernels in a single longitudinal axial threshing device, the range of values for each factor level in the orthogonal test was determined and a single factor threshing test was conducted on maize cobs in the 32-34% moisture content range. All three factors examined were tested in a 5-level single-factor test on the basis of prior art, with three replications of each level and the mean value taken as the final result.

Speed single factor test: The basic parameters in the speed single factor test are determined with reference to existing threshing techniques and requirements. At this stage of the multi-row high efficiency maize seed combine harvester, its threshing device cob feeding capacity needs to reach about 10 kg/s, so the cob feeding capacity in the speed single factor test is 10 kg/s. The gap between the concave plates is set at 40 mm in reference to the well-established spike-tooth threshing devices in the market. The speed of the roller has been explored in preliminary tests to find a better value at around 400 r/min. The speed test was conducted at 75 r/min as a unit and five levels were selected for threshing at 250/325/400/475/550 r/min respectively.

RESULTS

The results of the single-factor test on roller speed are shown in Table 3 below. A line graph of drum speed versus test indexes based on the test results is shown in Figure 2.

Table 3

Results of single factor tests on drum speed

Test serial number	Test factors			Test indicators			
	Roller speed (r/min)	Concave plate clearance (mm)	Feeding volume (kg/s)	Crushing rate (%)	Un-threshing rate (%)	Loss rate (%)	Impurity rate (%)
1	250	40	10	10.264	1.080	5.310	2.120
2	325	40	10	7.845	0.130	1.345	4.230
3	400	40	10	8.716	0.028	0.456	4.450
4	475	40	10	11.233	0.018	0.631	4.780
5	550	40	10	12.452	0.009	0.185	5.130

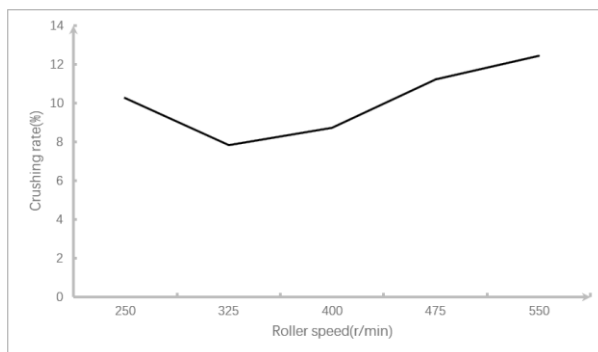

(a)

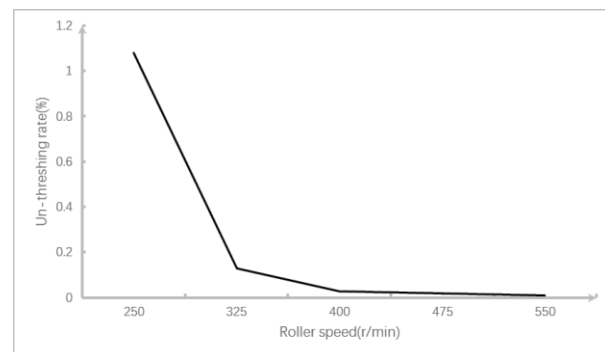

(b)

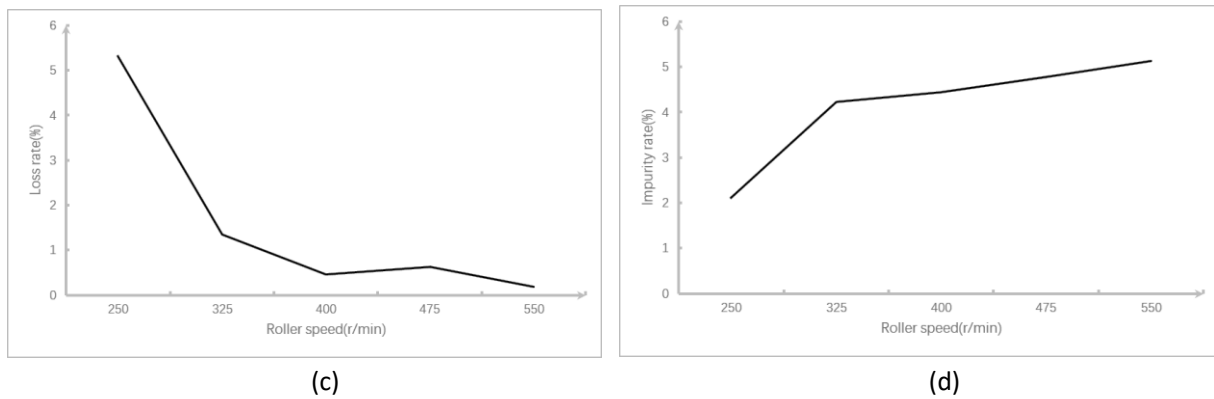

Fig. 2 - Effect of drum speed on test index

Incomplete threshing at low roller speed, high un-threshing rate and low crushing rate. When the drum speed is low, the threshing is incomplete, the un-threshing rate is high and the crushing rate is low; when the speed is increased to a suitable level, the un-threshing rate is effectively reduced and the crushing rate is at a low level; when the drum speed is continued to be increased, the impact of the rod teeth on the seeds is increased and the crushing rate rises faster, but the reduction is not significant because the un-threshing rate is at a low level. The loss rate is higher at lower speeds because the threshing element fails to separate out the seeds caught in the bracts and leaves. Significant improvement in loss ratio after increasing speed. The trash content increases at higher speeds as a result of stronger drum strikes on the mandrel.

Single factor test for concave plate clearance: The basic parameters in the single-factor test for concave plate clearance were determined with reference to the results of the single-factor test for speed and the requirements of high-feed maize seed harvesting machinery. Based on the results of the single-factor test on speed, the drum speed was set at 325 r/min for the 32-34% moisture content corn cob threshing test; the cob feeding rate was set at 10 kg/s for the corn cob threshing test in both moisture content zones based on the efficiency requirements of the multi-row high efficiency corn seed harvester.

The concave plate gap test was still selected at 5 levels, with a single factor threshing test for the gap at 30/35/40/45/50 mm respectively.

The results of the single factor test for the concave plate clearance are shown in Table 4 below. A line graph of concave plate clearance versus test index based on the test results is shown in Figure 3.

Table 4

Single-factor test results for concave plate clearance

Test serial number	Test factors			Test indicators			
	Roller speed (r/min)	Concave plate clearance (mm)	Feeding volume (kg/s)	Crushing rate (%)	Un-threshing rate (%)	Loss rate (%)	Impurity rate (%)
1	325	30	10	8.245	0.052	0.683	4.210
2	325	35	10	7.537	0.049	0.532	4.780
3	325	40	10	7.215	0.076	0.465	4.650
4	325	45	10	7.657	0.113	0.895	3.650
5	325	50	10	7.983	0.253	1.214	7.240

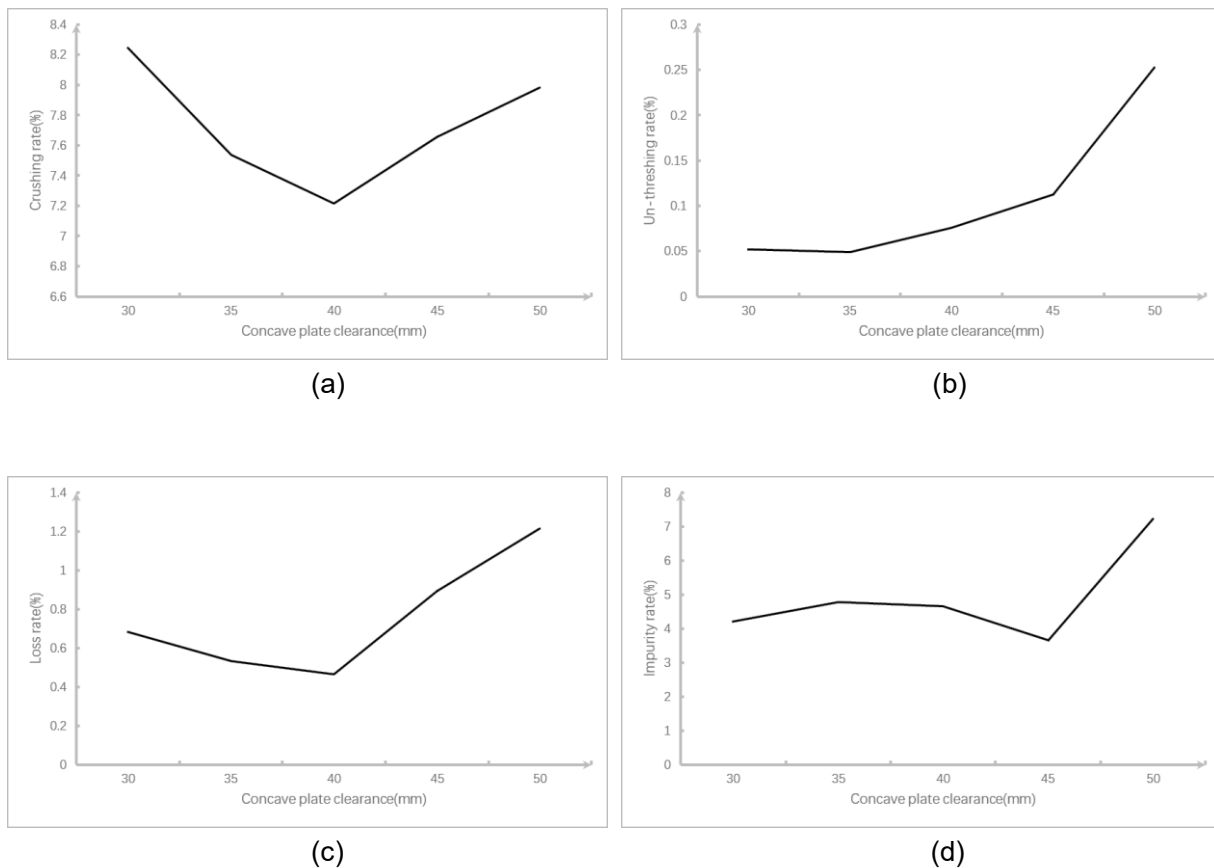

Fig. 3 - Effect of concave plate gap on test index

The gap between the threshing drum and the threshing concave plate is called the threshing gap or concave plate gap. When the gap between the concave plates is small the crop layer thickness is thin, allowing full contact with the threshing drum, resulting in a high rate of threshing but also a high rate of crushing. The increase in the gap between the concave plates to the right size and the increase in the crop layer thickness reduces the frequency of the rod tooth strikes on the seeds, the crushing rate decreases and the increase in the unstripped rate is not significant. The concave plate gap continues to increase, the un-threshing rate increases significantly, the flow rate of the crop layer thickness gradually decreases, the corn threshing time increases and the crushing rate increases.

Loss rate increases and then decreases with increasing clearance. The loss rate increases and then decreases as the gap increases, because the initial gap is small, the threshing time is short and some of the kernels are carried out by the maize bracts, after increasing the gap the threshing time is extended and the bracts and kernels are completely separated.

The gap continues to increase, the effect of the threshing element on the layer thickness diminishes and entrapment losses increase. The increased threshing gap extends the threshing time and leads to increased fragmentation of the mandrel and consequently increased trash content.

One-way test of feeding rate:

The basic parameters in the single-factor test for feed rate are determined by the results of the single-factor test for speed and the single-factor test for the gap between the concave plates. Based on the results of the single-factor test on speed, the drum speed was set at 325 r/min for the 32-34% moisture content maize threshing test. Based on the results of the single-factor test on the gap between the concave plates, the gap between the concave plates for the 32-34% moisture content maize threshing test was 40 mm. Five levels of maize cob feeding were still selected, with 2 kg/s as a unit, and feeding rates were tested at 6/8/10/12/14 kg/s for one-way feeding rates.

The results of the single-factor test for the feed rate are shown in Table 5 below.

A line graph of feeding rate versus test index based on the test results is shown in Figure 4.

Table 5

Results of the one-way feeding rate test

Test serial number	Test factors			Test indicators			
	Roller speed (r/min)	Concave plate clearance (mm)	Feeding volume (kg/s)	Crushing rate (%)	Un-threshing rate (%)	Loss rate (%)	Impurity rate (%)
1	325	40	6	9.107	0.111	0.935	2.750
2	325	40	8	7.853	0.045	0.465	3.570
3	325	40	10	7.557	0.049	0.435	4.210
4	325	40	12	8.475	0.237	0.946	2.000
5	325	40	14	9.229	0.378	0.975	2.660

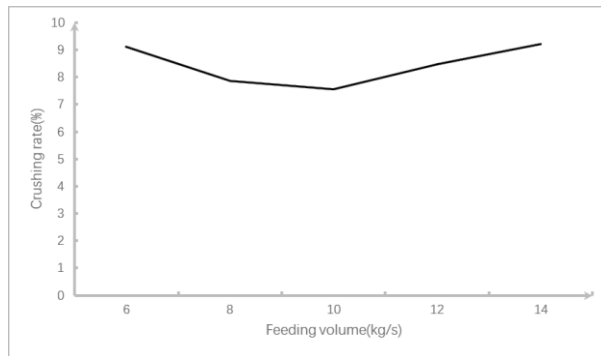

(a)

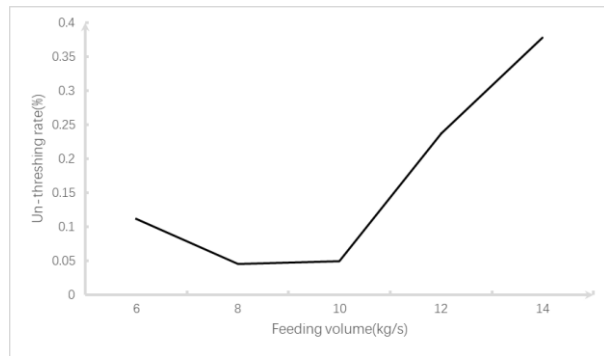

(b)

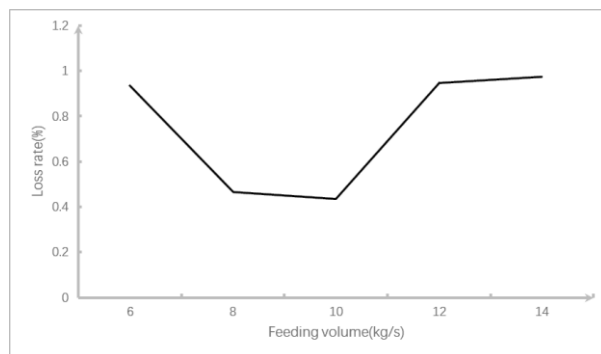

(c)

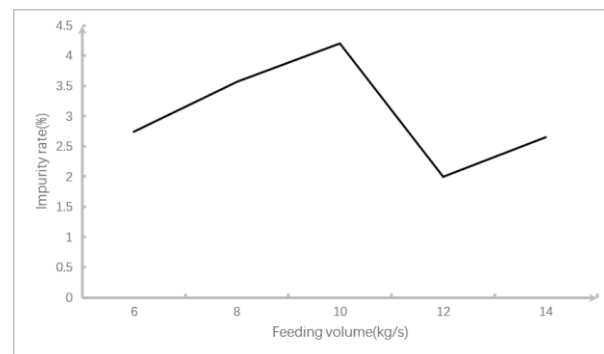

(d)

Fig. 4 - Effect of feeding rate on test indicators

The crop does not flow steadily in the gap when the feed rate is small, which increases the threshing time, the crushing rate is high, the un-threshing rate is low and the loss rate and the trash rate of the threshing product are high; as the feed rate increases, the layer thickness increases, the trash rate of the threshing product increases, the loss rate decreases, the crop flows steadily in the gap, the crushing rate decreases and the un-threshing rate decreases; as the feed rate continues to increase, the layer thickness of the crop increases, the bottom crop does not have sufficient contact with the drum, the top crop is hit too often and the flow rate decreases.

The bottom layer of crop does not have sufficient contact with the drum, the top layer of crop is hit too often and the flow rate decreases, at this time the crushing rate continues to increase, the unthawed rate increases significantly, the loss rate increases, the trash rate increases and the risk of clogging of the threshing device increases.

Orthogonal tests

In order to obtain the optimum ratio of parameters for the single longitudinal axial threshing device for threshing maize cobs in different moisture content zones, orthogonal tests were conducted based on the results of single-factor tests.

Based on the results of the single-factor test, three optimal levels were selected for each of drum speed, notch gap and cob feed, and a four-factor, three-level orthogonal test was arranged according to the L9(34) orthogonal table, with an empty column for the fourth factor. Analysis of variance (ANOVA) and response surface analysis (RSA) were conducted to obtain the significance of the three investigated factors on the investigated indexes and the optimum parameter ratios for the threshing device.

Based on the results of the 32-34% maize single-factor threshing test, three better levels were selected from each of the single-factor tests of drum speed, notch gap and feed rate to form the test factor arrangement table, as shown in Table 6.

Table 6

Test factors and levels

Factors Levels	Roller speed A (r/min)	Concave plate clearance B (mm)	Feeding volume C (kg/s)
-1	325	35	9
0	350	40	10
1	375	45	11

The orthogonal tests were conducted according to the standard four-factor, three-level test factor arrangement table, with each group of tests repeated three times and the mean value taken as the final result. The arrangement of the test factors and the results are shown in Table 7.

Table 7

Results of orthogonal tests

Test serial number	Test factors			Test indicators			
	Roller speed A	Concave plate clearance B	Feeding volume C	Crushing rate (%)	Un-threshing rate (%)	Loss rate (%)	Impurity rate (%)
1	0	-1	1	7.244	0.199	1.001	6.738
2	-1	0	-1	7.102	0.256	1.201	4.378
3	0	0	0	6.376	0.159	0.890	4.722
4	0	1	1	7.024	0.189	0.952	6.210
5	1	0	-1	9.112	0.251	1.125	4.504
6	-1	1	0	7.410	0.304	1.524	4.772
7	0	0	0	6.396	0.155	0.890	4.754
8	0	0	0	6.588	0.151	0.881	4.708
9	1	-1	0	10.002	0.238	1.257	4.448
10	0	0	0	6.540	0.161	0.904	4.810
11	-1	0	1	7.562	0.272	1.121	7.114
12	1	1	0	7.476	0.281	1.085	4.024
13	0	1	-1	6.828	0.197	0.926	4.874
14	-1	-1	0	7.404	0.268	1.101	4.302
15	0	0	0	6.560	0.158	0.895	4.750
16	1	0	1	9.548	0.221	0.997	6.442
17	0	-1	-1	7.244	0.199	1.001	6.738

Crushing rate analysis

Analysis of variance (ANOVA) was carried out using Design-Expert 10 software on the crushing rate and test factors as shown in Table 8 below; A, B, AB and A² were highly significant for crushing rate, C² was significant for crushing rate and all other factors were not significant for crushing rate, the fitted curve for crushing rate was obtained by removing the insignificant items.

Table 8

Correlation analysis between crushing rate and test factors

Test factors	P
A	0.0002
B	0.0088
C	0.3268
AB	0.0058
AC	0.9714
BC	0.6317
A ²	< 0.0001
B ²	0.2823
C ²	0.0264

Note: $P < 0.01$ (extremely significant); $0.01 < P < 0.05$ (significant); $P > 0.05$ (not significant).

Fitted curve after removal of insignificant terms:

$$S = 6.57 + 0.83 \times A - 0.41 \times B - 0.63 \times AB + 1.14 \times A^2 + 0.45 \times C^2 \tag{5}$$

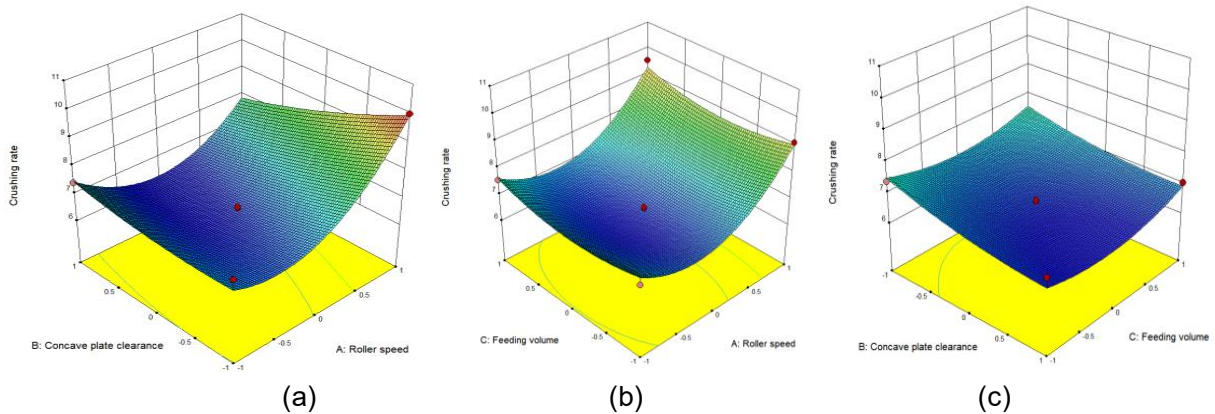

Fig. 5 - Response surface analysis of crushing rate

The response surface analysis shown in Figure 5 gives a minimum crushing rate of 6.241% at a drum speed level of -0.138, a concave plate gap level of 0.878 and a feed rate level of -0.261. At this point the drum speed level is 346.55 r/min, the concave plate gap level is 44.39 mm and the feed rate level is 9.739 kg/s.

Analysis of the non-decontamination rate

The analysis of variance (ANOVA) was carried out using Design-Expert 10 software on the undelivered rate and the test factors, as shown in Table 9 below; A, B, A² and B² were highly significant for the undelivered rate, while the other factors were not significant for the undelivered rate.

Table 9

Correlation analysis of the non-decontamination rate with the test factors

Test factors	P
A	0.0081
B	0.0223
C	0.9484
AB	0.7494
AC	0.0653
BC	0.2255
A ²	< 0.0001
B ²	0.0009
C ²	0.3015

Note: $P < 0.01$ (extremely significant); $0.01 < P < 0.05$ (significant); $P > 0.05$ (not significant).

Fitted curve after removal of insignificant terms:

$$Z = 0.15921 - 0.013625 \times A + 0.010875 \times B + 0.087776 \times A^2 + 0.028776 \times B^2 \tag{6}$$

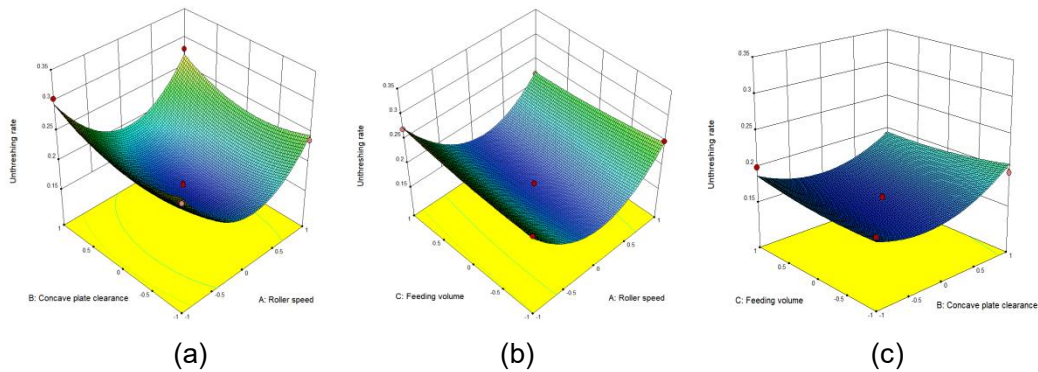

Fig. 6 - Response surface analysis of the unpurged rate

The response surface analysis shown in Figure 6 gives a minimum uncut rate of 0.155% at a drum speed level of 0.079, a concave plate gap level of -0.196 and a feed rate level of -0.026. At this point the drum speed level is 351.975 r/min, the concave gap level is 39.02 mm and the feed rate level is 9.74 kg/s.

Loss ratio analysis

Analysis of variance (ANOVA) was carried out on the loss rates and test factors using Design-Expert 10 software, as shown in Table 10 below; AB and A² were highly significant for loss rates, A and B² were significant for crushing rates and all other factors were insignificant for loss rates.

Table 10

Correlation analysis of loss rates with test factors

Test factors	P
A	0.0245
B	0.1828
C	0.7374
AB	0.0016
AC	0.7000
BC	0.4439
A ²	< 0.0001
B ²	0.0184
C ²	0.1949

Note: $P < 0.01$ (extremely significant); $0.01 < P < 0.05$ (significant); $P > 0.05$ (not significant).

Fitted curve after removal of insignificant terms:

$$Q = 0.87 - 0.06 \times A - 0.15 \times AB + 0.26 \times A^2 + 0.087 \times B^2 \tag{7}$$

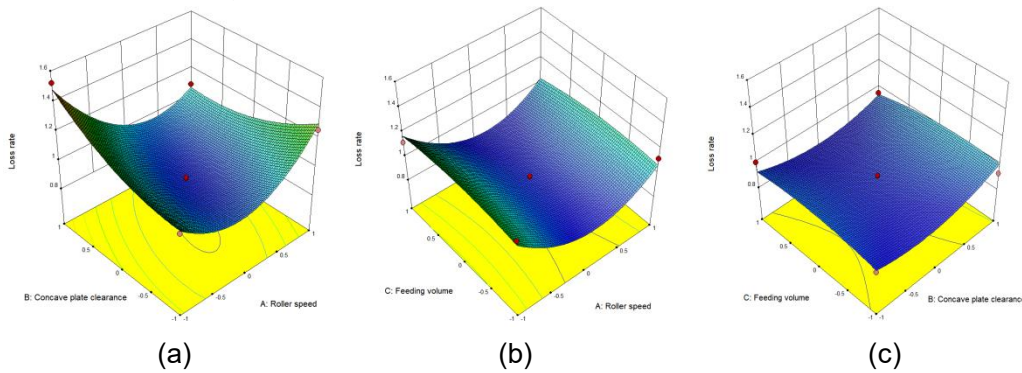

Fig. 7 - Loss rate response surface analysis

The response surface analysis shown in Figure 7 gives a minimum loss rate of 0.841% at a drum speed level of 0.137, a concave plate gap level of 0.161 and a feed rate level of 0.964. At this point the drum speed level is 353.425 r/min, the concave gap level is 40.805 mm and the feed rate level is 10.964 kg/s.

Analysis of trash content

Analysis of variance (ANOVA) was carried out using Design-Expert 10 software on the impurity rates and the test factors as shown in Table 11 below; A, C, AB, AC, BC, B² and C² were highly significant for the impurity rates, while the other factors were not significant for the impurity rates.

Table 11

Correlation analysis of trash content with test factors

Test factors	P
A	0.0042
B	0.2445
C	< 0.0001
AB	0.0025
AC	0.0046
BC	0.0002
A ²	0.0546
B ²	0.0011
C ²	< 0.0001

Note: P < 0.01 (extremely significant); 0.01 < P < 0.05 (significant); P > 0.05 (not significant).

Fitted curve after removal of insignificant terms:

$$Y = 4.7 - 0.14 \times A + 1.09 \times C - 0.22 \times AB - 0.2 \times AC - 0.34 \times BC - 0.26 \times B^2 + 0.96 \times C^2 \tag{8}$$

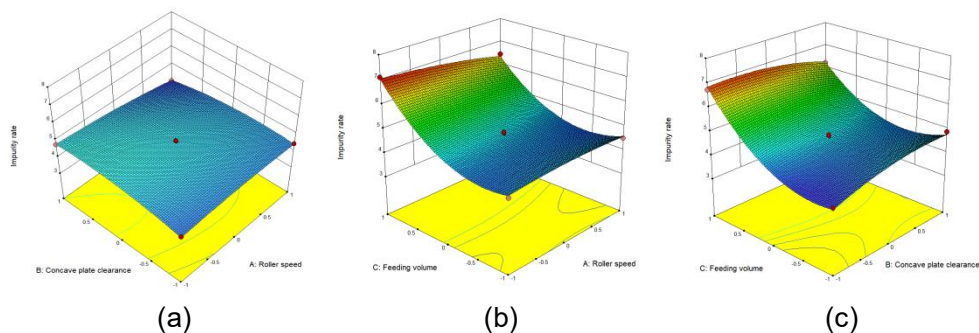

Fig. 8 - Response surface analysis of the impurity rate

The response surface analysis shown in Figure 8 gives a minimum contamination rate of 3.676% at a drum speed level of -0.845, a concave gap level of -0.976 and a feed level of -0.769. At this point the drum speed level is 328.875 r/min, the gap between the concave plates is 35.12 mm and the feed rate is 9.231 kg/s.

Analysis of test results

In order to compare the crushing rate with the entrainment loss rate, the lowest crushing rate is more representative of the total harvest loss, so the response surface analysis in Design-Expert 12.0 is used to find the best parameters for the lowest crushing rate. The lowest crushing rate of 6.241% was taken, when the drum speed level was 346.55 r/min, the concave plate gap level was 44.39 mm and the feed rate level was 9.739 kg/s.

All other parameters were held constant and the test was repeated three times using a harvester test rig. To facilitate the adjustment of equipment parameters, the drum speed level was taken to be 346.5 r/min, the concave plate gap level was 45 mm and the feed rate level was 9.7 kg/s. The average crushing rate for the three times was taken to be 6.311%, which was similar to the 6.241% obtained from the response surface analysis, at which time the un-delivered rate was 0.187%, the entrained. The loss rate was 0.912% and the impurity rate was 4.251%. The test proved that the results from the experimental analysis were consistent with the actual working results.

CONCLUSIONS

This study addresses the problem of high moisture content maize harvesting losses by designing a maize harvesting trial based on a harvester test bed designed by our group, effectively simulating a maize harvesting field trial and collecting accurate data parameters.

In order to determine the optimum operating parameters of the harvester for maize harvesting, single-factor tests and orthogonal tests were conducted using threshing drum speed, threshing clearance and feed rate as test factors, and crushing rate, un-threshing rate, entrainment loss rate and trash content rate as evaluation indicators. The response surface analysis of the test factors was used to derive the influence of the factors on the response indicators.

The optimum operating parameters were obtained when harvesting maize at 32% to 34% moisture content with the lowest crushing rate. The optimum operating parameters were: drum speed of 346.55 r/min, concave plate clearance of 44.39 mm and feed rate of 9.739 kg/s, at which time the crushing rate was 6.311%, the un-threshing rate was 0.187%, the entrained loss rate was 0.912% and the trash content was 4.251%. The results of the verification experiments show that the test results are consistent with the actual work.

ACKNOWLEDGEMENT

The work was supported by the High Efficiency and Low Loss Single Longitudinal Axial Flow Threshing and Separation Technology and Development of Intelligent Flexible Threshing Device, (Grant No.2021YFD200050204), and the Development of Intelligent Multifunctional Wheat Corn Grain Combine Harvester, (Grant No.2016YF026).

REFERENCES

- [1] Craessaerts G., Baerdemaeker J.D., Missotten B. et al. (2010). Fuzzy control of the cleaning process on a combine harvester. *Biosystems Engineering*, Vol. 106, No. 2, 103-111.
- [2] Du Hongyong, Zhang Heng, Li Haoze et al. (2020). Research on Optimization of Cleaning Parameters of Corn Threshing and Cleaning Test Bench. (玉米脱粒清选试验台清选参数优化研究). *Journal of Agricultural Mechanization Research*, Vol. 42, No. 9, 166-172+180.
- [3] Federico Dettù, Matteo Corno, Daniele D'Ambrosio, et al. (2023). Modeling, control design and experimental automatic calibration of a leveling system for combine harvesters. *Control Engineering Practice*, Vol.132, No. 105411.
- [4] Ildar Badretdinov, Salavat Mudarisov, Ramil Lukmanov et al. (2019). Mathematical modeling and research of the work of the grain combine harvester cleaning system. *Computers and Electronics in Agriculture*, Vol.165, No. 104966.
- [5] Li Jiasheng, Li Yaoming, Xu Lizhang et al. (2022). Design and performance test of ratoon rice threshing separation device. (再生稻联合收获机脱粒分离装置的设计与试验). *Journal of Agricultural Mechanization Research*, Vol. 44, No. 2, 85-89.

- [6] Miu P.I., Kutzbach H.D. (2007). Mathematical model of material kinematics in an axial threshing unit. *Computers & Electronics in Agriculture*, Vol. 58, No. 2, 93-99.
- [7] Omid M., Lashgari M., Mobli H. et al. (2010). Design of fuzzy logic control system incorporating human expert knowledge for combine harvester. *Expert Systems with Applications*, Vol. 37, No. 10, 7080-7085
- [8] Pan Xiaofeng. (2017). *Research on the Development of Agricultural Mechanization in Shandong Province* (山东省农业机械化发展研究) [Master's dissertation, Shandong Agricultural University].
- [9] Qu Zhe. (2018). *Research on Combined Maize Threshing and Separating Device with Low Damage*. (低损伤组合式玉米脱粒分离装置的研究). [Doctoral dissertation, China Agricultural University].
- [10] Shamilah Ahmad Mokhtor, Darius El Pebrian, Nor Azi Asminda Johari. (2020). Actual field speed of rice combine harvester and its influence on grain loss in Malaysian paddy field. *Journal of the Saudi Society of Agricultural Sciences*, Vol.19, No. 6, 422-425.
- [11] Shen Yufeng, Wu Mingliang, Wu Zigao et al. (2013). Structural design of a longitudinal axial flow rice combine harvester cleaning system. (纵轴流式水稻联合收割机清选系统结构设计). *Journal of Hunan Agricultural University (Natural Sciences)*, Vol. 39, No. S1, 94-96.
- [12] Song Zhicai, Diao Peisong, Chen Meizhou et al. (2022). Analysis Design and Test of Longitudinal Flow Corn Threshing and Separating Plant. (纵轴流玉米脱粒分离装置设计与试验). *Journal of Agricultural Mechanization Research*, Vol. 44, No. 2, 58-66.
- [13] Tiwari P.S., Pandey M.M., Gite L P, et al. (2010). Effect of operating speed and cob size on performance of a rotary maize sheller. *Journal of Agricultural Engineering*, Vol.47, No.2, 1-8.
- [14] Vlăduț N.V., Biris S.St., Cârdei P. et al. (2022). Contributions to the mathematical modeling of the threshing and separation process in an axial flow combine. *Agricultural*, Vol. 12, No. 10, 1520.
- [15] Wang Xunwei, Xie Fangping, Li Xu et al. (2019). Design and experiment on threshing and separation device with adjustable concave clearance. (可调间隙脱粒分离装置的设计与试验). *Journal of Hunan Agricultural University (Natural Sciences)*, Vol. 45, No. 2, 205-211.
- [16] Xie Dongmei. (2021). *Study on the Influence of Agricultural Mechanization Development on China's Grain Production*. (农业机械化发展对中国粮食生产的影响研究) [Doctoral dissertation, Southwest University of Finance and Economics].
- [17] Zhang Lina. (2017). *Study on the Influence of Mechanized Production on Competitiveness of Maize Industry in China*. (机械化生产对我国玉米产业竞争力影响的研究) [Doctoral dissertation, China Agricultural University].
- [18] Zhao Dechun, Yu Tao, Cai Xiaohua. (2010). Design on Ordinate Axial Threshing and Separating Test-bed. (纵轴流脱粒分离试验台的设计). *Journal of Agricultural Mechanization Research*, Vol. 22, No.7, 121-123.